



DEED 2006064045



JUN 08 2006 12:17 P 60

Nebr Doc Stamp Tax
<u>6/8/06</u> Date
<u>\$ 5x04</u>
By <u>DK</u>

**DECLARATION
AND
MASTER DEED
OF STONE CREEK VILLAGE
CONDOMINIUM PROPERTY REGIME**

Received - DIANE L. BATTIATO
Register of Deeds, Douglas County, NE
6/8/2006 12:17:29.47



2006064045

This Declaration and Master Deed of Stone Creek Village Condominium Property Regime is made and entered into this 7th day of June, 2006, by Triton Homes, L.C., an Iowa limited liability company, doing business in Nebraska as Triton Homes, LLC, hereinafter referred to as "Declarant".

WITNESSETH:

WHEREAS, pursuant to the terms of the Nebraska Condominium Act, Neb. Rev. Stat. §76-825 et. seq. (hereinafter referred to as the "Act"), Declarant, as the sole record owner of the Property legally described in Exhibit "A" attached hereto and incorporated herein by this reference (hereinafter referred to as the "Property") does hereby subject the Property to the condominium form of ownership as "Stone Creek Village Condominium Property Regime," as provided for in the Act and in this Declaration and Master Deed of Stone Creek Village Condominium Property Regime (hereinafter referred to as the "Declaration").

WHEREAS, by virtue of the recording of this Declaration, the Property shall be owned, held, transferred, sold, conveyed, used, occupied and mortgaged or otherwise encumbered subject to the provisions of this Declaration and the Act and every grantee of any interest in said Property, by acceptance of a deed or other conveyance of such interest, and every Owner of any portion of the Property, whether or not such deed or other conveyance of such interest shall be signed by such person and whether or not such person shall otherwise consent in writing, shall own and take subject to the provisions of the Act and this Declaration and shall be deemed to have consented to the terms hereof.

WHEREAS, in addition to the formation of this Condominium, to be comprised of the Property aforementioned, Declarant hereby further reserves unto itself and its successors and assigns acting as Declarant, Special Declarant Rights, as defined in the Act, to include by way of example and not limitation, the right to exercise Development Rights, as defined in the Act,

Upon recording return to:
Mark LaPuzza
Pansing Hogan Ernst & Bachman LLP
10250 Regency Circle, Suite 300
Omaha, NE 68114

Handwritten: 204.00 05-37088-ald
 BNP _____ C/O _____
 DEL _____ SPAN _____

including the right and option, but not the obligation, in its own discretion and by its own act, to (i) relocate the boundaries of any Unit or Units, (ii) further subdivide any one or more of the Units into additional Units, Common Elements or both, and (iii) annex additional property to be subject to the Declaration, as detailed on the Plans, as further defined herein below and as attached on Exhibit "B" attached hereto, all as further provided in Article XV of this Declaration and pursuant to the terms of the Act.

WHEREAS, in furtherance of the plan of condominium ownership and the purposes and intents thereof, Declarant, sole owner of the Property hereby submitted to the Act and this Declaration, together with all Improvements constructed thereon, hereby makes this Declaration which shall apply to, govern, control and regulate the sale, resale, or other disposition, acquisition, ownership, use and enjoyment of the Property and the Improvements located thereon, and does hereby specify, agree, designate and direct that this Declaration and all of its provisions shall be and are covenants to run with the Property herein described and shall be binding on the present owner of the Property and all its successors and assigns and all subsequent owners of the Property and Improvements constructed thereon, together with their grantees successors, heirs, executors, administrators, devisees and assigns.

NOW, THEREFORE, Declarant, as the owner of the Property located in Douglas County, Nebraska, and as described in Exhibit "A" attached hereto, for the purposes above set forth, does hereby declare said Property and all Improvements and facilities constructed thereon to be a condominium property regime hereunder known as the Stone Creek Village Condominium Property Regime, under the Act and in furtherance thereof declares and provides:

**ARTICLE I
DEFINITIONS**

The following terms, as used herein or elsewhere in any of the Condominium documents relating to the Stone Creek Village Condominium Property Regime, unless otherwise provided, are defined as follows:

1.1 Allocated Interests means the undivided interest in the Common Elements and Common Expense Liability allocated to each Unit, as calculated under this Declaration.

1.2 Articles of Incorporation means the Articles of Incorporation of the Association as the same now exist or may be hereafter amended.

1.3 Association means Stone Creek Village Condominium Association.

1.4 Association's Board of Directors, Board of Directors or Board means the Board of Directors of the Association, the members of which shall be elected from time to time as provided in this Declaration and the Bylaws and the Articles of Incorporation and shall be elected pursuant to the terms of the Act. The Board of Directors shall be the governing body of the Association and may sometimes herein be referred to as the Board or the Executive Board.

1.5 Bylaws means the Bylaws of the Association as the same now exist or may be

hereafter amended.

- 1.6 City means the City of Omaha, Nebraska.
- 1.7 Common Elements means all portions of the Condominium other than the Units.
- 1.8 Common Expenses means expenditures made by or financial liabilities of the Association, together with any allocations to reserves.
- 1.9 Common Expense Liability means the liability for Common Expenses allocated to each Unit pursuant to the terms of this Declaration and the Act.
- 1.10 Condominium, Condominium Regime or Condominium Project means the Real Estate described in Exhibit "A" attached hereto and incorporated herein by this reference, portions of which are designated for separate ownership and the remainder of which is designated for common ownership solely by the owners of those portions.
- 1.11 Declarant means Triton Homes, L.C., an Iowa limited liability company, doing business in Nebraska as Triton Homes, LLC, and its successors and assigns in interest who succeed to any Special Declarant Rights inclusive of the Developments Rights.
- 1.12 Declaration means this Declaration and Master Deed of Stone Creek Village Condominium Property Regime, as such may be amended from time to time.
- 1.13 Development Guidelines or Guidelines shall mean the design and development guidelines and standards and the review and approval procedures that may be prepared and issued from time to time by the respective Committees pursuant to Article VI, below, for the purpose of assisting lessees, the Unit Owners and Purchasers in preparing development and improvement plans for a Unit within the Condominium Regime.
- 1.14 Development Rights means any right, or combination of rights, reserved by the Declarant in this Declaration to add Real Estate to the Condominium, to create Units, Common Elements or Limited Common Elements within the Condominium, to subdivide Units or convert Units into additional Units, Common Elements or both; or to relocate the boundaries of any Unit within the Condominium Regime, including the rights reserved to Declarant as set forth in Article XII, below.
- 1.15 Dispose or Disposition means a voluntary transfer to a Purchaser of any legal or equitable interest in a Unit, but does not include the transfer or release of a security interest.
- 1.16 Eligible Mortgage means any of the following (i) any first mortgage; (ii) any junior instrument recorded or filed in the office of the Register of Deeds of Douglas County, Nebraska, encumbering a Unit or any portion thereof as security for the performance of an obligation given in good faith and for valuable consideration which is not a fraudulent conveyance under Nebraska law, including, without limitation, a deed of trust that has been approved by the Board, but does not mean any instrument creating or evidencing solely a

security interest arising under the Uniform Commercial Code or an encumbrance affecting any leasehold interest in a Unit (such as leasehold mortgage).

1.17 Identifying Number means a symbol or address which identifies only one Unit in the Condominium Project.

1.18 Improvements shall mean all buildings, structures, underground installations, slope and grade alterations, lighting, elevators, walkways, gutters, storm drains, drainageways, utilities, driveways, screening walls, walls, exterior doors, windows, window boxes, awnings, stairs, stairwells, decks, patios, balconies, plantings, planted trees and shrubs, sidewalks, poles, flags, signs, storage or display areas, loading areas, docks, fountains, water features, facilities and all other structures or improvements of every type and kind.

1.19 Limited Common Element means a portion of the Common Elements allocated by this Declaration, the Bylaws or by the Act for the exclusive use of one or more but fewer than all of the Units. Any Limited Common Element shown on the Plans shall be for the exclusive use of the Unit or Units immediately adjoining such Limited Common Element.

1.20 Managing Agent means the Person who undertakes the duties, responsibilities and obligations of the management of the Association and the Condominium. Managing Agent may be employed or terminated by a vote of the Board of Directors, subject to any outstanding contract rights as might exist. A Managing Agent must be a Person that is a professional in the field of property management.

1.21 Parking Space means any parking space located in the Condominium Project as may be shown on the Plans.

1.22 Period of Declarant Control shall commence with the recording of this Declaration and shall continue until the earlier of (i) sixty (60) days after the date by which seventy-five (75%) percent of the Units have been conveyed to Unit Purchasers, or (ii) two (2) years after the date the Declarant has ceased to offer Units for sale in the ordinary course of its business, or (iii) seven (7) years after the date this Declaration is recorded in the office of the Register of Deeds of Douglas County, Nebraska, or (iv) three (3) years after the first Unit is conveyed to an Owner other than Declarant.

1.23 Person means a natural person, corporation, partnership, limited liability company, business trust, estate, trust, partnership, association, joint venture, government, governmental subdivision or agency, or other legal or commercial entity; provided, however, that for a land trust, "Person" means the beneficiary of the trust rather than the trustee of the trust.

1.24 Plan or Plans means the drawings prepared by a registered architect or engineer which contain the information required by the provisions of the Act and as set forth on Exhibit "B".

1.25 Purchaser means any Person other than a Declarant or a Person in the business of selling Real Estate for his own account, who by a voluntary transfer acquires a legal or equitable

interest in a Unit, other than (a) a leasehold interest, including renewal options of less than twenty (20) years, or (b) as security for an obligation.

1.26 Qualified Lender means any bank, insurance company or other financial institution qualified to do business in the State of Nebraska, Declarant, its successors, assigns, affiliates or subsidiaries, a holder, insurer or governmental guarantor of an Eligible Mortgage, or any other lender approved by the Board.

1.27 Real Estate means any leasehold or other estate or interest in, over, or under land including structures, fixtures, and other improvements and interest which by custom, usage, or law pass with a conveyance of land though not described in the contract of sale or instrument of conveyance. "Real Estate" includes parcels with or without upper or lower boundaries, and spaces which may be filled with air or water and specifically includes the Property.

1.28 Special Declarant Rights means rights reserved for the benefit of the Declarant to complete Improvements indicated on the Plans filed with the Declaration; to exercise any Development Rights; to maintain sales offices, management offices, advertising signs for the Condominium Project, and models; to use easements through the Common Elements (including the Limited Common Elements) for the purpose of making Improvements within the Condominium Project; to create or add additional Units, Common Elements, or both; to relocate the boundaries between any of the Unit or Units; to subdivide any Unit or Units; or to appoint or remove any officer of the Association, or any member of the Board of Directors during the Period of Declarant Control.

1.29 Super-Majority Vote shall mean sixty-seven (67%) percent or more of the votes entitled to be cast by the members of the Association at any regular or special meeting of the Association called for that purpose.

1.30 Unit means a physical portion of the Condominium designated for separate ownership or occupancy, the boundaries of which are described in Article II, below, in the Plans and pursuant to the Act.

1.31 Unit Owner or Owner shall mean the fee simple interest Owner of any Unit or Units, including, without limitation, one who is buying a Unit or Units under a recorded contract, but excluding Mortgagees and others who hold such title merely as security. Owner shall not include a Lessee of a Unit or Units.

ARTICLE II CONDOMINIUM UNITS

2.1 The Units. The Condominium Units shall be legally described as shown on the Plans attached hereto as Exhibits "B". The Condominium Project shall consist of not less than seven (7) nor more than one hundred thirty-seven (137) Units. Additional Units may, from time to time, be added. Each Unit includes an Allocated Interest that is appurtenant thereto. The Units are further identified on the Plans recorded pursuant to the terms of this Declaration and the Act. Each Unit's appurtenant percentage of undivided interest in the Common Elements

shall be allocated as set forth in Exhibit "C" attached hereto and incorporated herein by this reference, subject to amendment and recalculation as set forth below. The calculation of this allocation shall be originally calculated by the Declarant based upon a fraction, the numerator of which is one (1), and the denominator of which is the total number of Units constructed in the Condominium Regime; provided, however, the Declarant shall calculate any reallocation of the percentage interests upon the creation of any additional Units, the relocation of the boundaries of any Units, the conversion of Units into Common Elements or the conversion of Common Elements into Units. For purposes of voting, each Unit is allowed one (1) vote, regardless of the number of Persons having an interest in such Unit. The Common Expense Liability shall be based on the operation and maintenance costs for these Common Elements and the amount of the assessment will change on a yearly basis according to these costs. Each Unit and corresponding garage allocated to such unit may be described by its Identifying Number or symbol as shown on the Plans and as set forth in this Declaration and shall be deemed good and sufficient for all purposes and shall be deemed to convey, transfer, encumber or otherwise affect the Unit Owner's corresponding Allocated Interests even though the same is not expressly mentioned or described therein. Ownership of each Unit and the Unit Owner's corresponding share in the Common Elements shall not be separated. Other than the Declarant, no Unit Owner may relocate the boundaries of any Unit or further subdivide or combine any one or more the Units, except as set forth in Section 6.6(a), below.

2.2 Dimension of Units. The Units and their dimensions are depicted on the Plans referred to hereinabove which Plans are incorporated herein by this reference. Except as otherwise provided herein, and as otherwise set forth in Article III, which describes the Common Elements, each Unit includes that part of the structure which lies within the following boundaries:

(a) The upper horizontal boundary of each of the Units shall be in the horizontal plane of the lowermost unfinished surface of the roof, such that the roof, and all of its support systems, shall not be deemed to be included within the boundaries of the Unit. The lower horizontal boundary of each Unit is the horizontal plane of the uppermost unfinished surface, such that the concrete slab of the foundation shall not be deemed to be included within the boundaries of the Unit.

(b) The vertical boundary (perimetric) of each Unit is the unfinished exterior perimeter wall surfaces of all such walls; provided that where there are windows or doors, the boundary is the exterior surface or such doors and windows when enclosed. Where a wall physically separates one Unit from another Unit, the boundary of such Units shall be from the internal surface of the drywall inward, such that the drywall, structural supports, utility service lines, and air space, if any, between two such Units shall be Common Elements, and shall not be deemed to be included within the boundaries of the Unit.

(c) The horizontal and vertical boundaries above identified shall be extended to their intersections with each other, but, as set forth in 2.2(b) above, vertical boundaries between Units shall run parallel and not abut.

2.3 Further Definition of Units. Included in the Units are systems, equipment, installations and facilities of the Unit which are exclusively used for the benefit of a particular Unit, whether situated within or outside of a particular Unit's boundaries, including, but not limited to the following:

(a) All internal walls or partitions which are contained wholly within a Unit shall be deemed part of the Unit;

(b) All central and appurtenant installations for services such as electrical, power, light, telephone, gas, hot and cold water and heat (including all ducts, pipes, valves, wires, cables and conduits used in connection therewith or any replacements thereof) which exclusively service a Unit;

(c) Fans, vents and exhausts and all piping, ducts and equipment which exclusively service a Unit wherever the same may be located;

(d) All exterior windows, doors, shutters, awnings, window boxes, balconies, and glass windows which exclusively service a Unit;

(e) Light fixtures, wiring, risers, electrical feeders, switches, electrical meters exclusively servicing a Unit;

(f) All other facilities or fixtures located within or immediately connected to a Unit which exclusively serve or benefit or are necessary for the existence, maintenance, operation or safety of the particular Unit.

(g) All lath, furring, wallboard, plasterboard, plaster, paneling, tiles, wallpaper, paint, finished flooring, and any other materials constituting any part of the finished surfaces of the walls, floors, or ceilings within the designated boundaries of any Unit are a part of that Unit.

No Unit shall include any piping, wiring, ductwork, machinery, equipment or other materials used exclusively by any other Unit.

ARTICLE III COMMON ELEMENTS

3.1 Common Elements. The Common Elements of the Condominium are as follows:

(a) The Real Estate upon which the structures containing the Condominium Units are located, and such structures themselves, including the foundations, exterior walls, roofs, gutters, downspouts, chutes, chases, flues, ducts, wires, conduits, bearing walls, bearing columns, fire suppression and detection systems, whether situated partially within or outside the boundaries of any Unit, including without limitation all piping, fittings, valves and sprinkler heads, or any other fixtures which lie partially within and

partially outside of the designated boundaries of a Unit and which serve more than one Unit and are not otherwise assigned or allocated to any one or more Units as a Limited Common Element.

(b) Except as may be shown on the Plans, the Common Elements shall include, without limitation, service or utility areas and facilities now or hereafter erected, constructed or installed on or in the Property and any adjacent public right-of-ways that the Association is responsible for maintaining, including without limiting the generality of the foregoing, trees, shrubs, lawns, decorative urns and planters, pavements, sidewalks, storm and water systems, sewage lines, and all utility installations, and pipes, wire and conduits and connections for television, electricity, light, water and plumbing and other utilities, except those items that are exclusively within or for the benefit of a particular Condominium Unit and not used to service any Unit other than that particular Condominium Unit.

(c) All other appurtenances not herein specifically designated which are not enclosed within the boundaries of a Condominium Unit as is hereinabove delineated in Article II of this Declaration.

3.2 Undivided Interest in Common Elements. The Owner of each Unit shall own an undivided interest in the Common Elements as a tenant (or tenants) in common with all the other Unit Owners, and, except as otherwise limited in this Declaration, shall have the right to use the Common Elements for the purposes incidental to the use and occupancy of said Unit, and such other incidental uses as may be permitted by this Declaration, which right shall be appurtenant to and run with such Person's or Persons' Unit. The extent and amount of percentage of such ownership shall be expressed by a percentage amount, the particular percentage amount, also sometimes referred to herein as "share", appertaining to each Unit being set forth in Exhibits "B" and "C" attached hereto and made a part hereof. The percentage interest appurtenant to the Unit may change in the event of the construction of additional Units, any Unit is converted to a Common Element, any Common Element is converted to a Unit or the boundaries of any Unit are relocated as authorized by the Act or this Declaration.

3.3 Allocated Share of Common Elements. The percentage interest or share allocated to each Unit shall be determined as set forth in Article II, above. Each Owner, by acceptance of the deed to a Unit, expressly agrees to the allocation and reallocation of the percentage interest set forth hereinabove or by exercise of any other Special Declarant Right. Allocations and reallocations of the percentage interest may be subject to minor variations attributable to rounding off. The respective percentage interest shall be computed to five significant figures so the sum of the percentage interests of all Units equals one hundred (100%) percent.

ARTICLE IV COVENANTS

4.1 No Partition of Common Elements. As long as the Property is subject to the provisions of the Act, the Common Elements shall remain undivided, and no Unit Owner or Owners shall bring any action for partition or division of the Common Elements; and any

agreement to the contrary shall be null and void. Provided, however, nothing herein contained shall prevent partition of a Condominium Unit as between any Persons who are Co-Owners thereof, if such right of partition shall otherwise be available, but such partition shall not be in kind.

4.2 No Severance of Ownership. No Owner shall execute any deed, mortgage, lease or other instrument affecting title to his or her Unit Ownership without including therein both his or her interest in the Unit and his or her corresponding Allocated Interests, including his or her share in the Common Elements, it being the intention hereof to prevent any severance of such combined ownership. Any such deed, mortgage, lease or other instrument purporting to affect the one without including also the other, shall be deemed and taken to include the interest so omitted even though the latter is not expressly mentioned or described therein.

4.3 Rights of Action. The Association, and any aggrieved Unit Owner, shall hold a right of action against any Owner who fails to comply with the provisions of this Declaration or the decisions made by the Association. Unit Owners shall have a right of action against the Association for violation of the Declaration.

**ARTICLE V
EASEMENTS AND LIMITED COMMON ELEMENTS**

5.1 Encroachments. In the event that, by reason of construction, settlement or shifting of any building or structure, any part of the Common Elements encroaches or shall hereafter encroach upon any part of any Unit, or any part of any Condominium Unit encroaches or shall hereafter encroach upon any part of the Common Elements, or if by reason of the design or construction of any Condominium Unit it shall be necessary to a Unit Owner to use or occupy, for normal uses and purposes, any portion of the Common Elements, consisting of an unoccupied space within the Property and adjoining his or her Unit, valid easements for the maintenance of such encroachment and for the use of such adjoining space are hereby established and shall exist for the benefit of such Condominium Unit and the Common Elements, as the case may be, so long as all or any part of the building containing such Unit shall remain standing; provided, however, that in no event shall a valid easement for an encroachment be created in favor of any Condominium Owner or in favor of the Owners of the Common Elements if such encroachment occurred because of the willful conduct of said Condominium Unit Owner or the Owners of the Common Elements, as the case may be. In the event any structure is partially or totally destroyed and then rebuilt, minor encroachments of part of the Common Elements because of construction shall be permitted and valid easements for said encroachment and the maintenance thereof shall exist.

5.2 Limited Common Elements. Unless the context of this Declaration otherwise requires, Limited Common Elements shall be as provided in the Act and assigned and allocated exclusively to the Units so served. The Board shall be expressly empowered and authorized to allocate parking exclusively to a Unit as shown on the Plans, which if allocated, shall be deemed to be a Limited Common Element appurtenant to such individual Unit. Allocation of such Parking Spaces as a Limited Common Element may be done by establishing on the Plans or amendment thereto adopted by the Board, the Unit's identifying number as respects any such

assigned or allocated Parking Space. Unit Owners may, with the prior written consent of the Board, which consent shall not be unreasonably withheld, reallocate, convey and transfer Parking Spaces among or between their Units by assignment, lease, easement or license. Other than a Unit Owner or any tenant occupying a Unit, no Person shall be assigned or allocated a parking stall within the parking garage. The Board shall not have any rights or authority to reassign or reallocate any Parking Space without the prior written consent of the Unit Owner affected thereby.

5.3 Easement to Unit Owners. Except as to the use of any Unit or Limited Common Elements that are assigned and allocated to any Unit or that are assigned and allocated exclusively to any other Unit, perpetual easements are hereby established for all Unit Owners, their families, guests, invitees, mortgagees and servants for the use and enjoyment of all Common Elements, subject to such rules and regulations as may from time to time be established by the Association herein provided. Except for the rights of the Declarant herein, no Owner of a Unit shall have any right to access, occupy or use any Limited Common Elements exclusively assigned and allocated to any other Unit.

5.4 Utility Easements. Easements as shown on the Plans or as may be hereafter established by the Association are established and dedicated for sewers, electricity, television, water, telephone and all other utility purposes, including the right to install, lay, maintain, clean, repair and replace water mains and pipes, sewer lines, drainage pipes and conduits, television wire and equipment, telephone wire and equipment, and electrical wires and conduits, over, under, along and across any portion of the Common Elements.

5.5 Easements in Gross. The Property shall be subject to a perpetual easement in gross to the Association provided herein, its successors and assigns, for ingress and egress, to perform its obligations and duties as required by this Declaration. Should it be necessary to enter any Condominium Unit to repair a Common Element or Limited Common Element, the employees, agents, contractors, subcontractors, or workmen shall be entitled to entrance during reasonable hours with 24 hours prior written notice, unless it is reasonably believed by the Board that an emergency exists which requires such entrance without advanced notice, by exhibiting to the Condominium Owner or any Person or Persons occupying such Unit under authority of such Condominium Unit Owner, an order signed by any member of the Board of Directors or signed by the Managing Agent.

5.6 Granting of Easements. The Association, acting through the Board, shall have the power to grant rights and restrictions, in the Common Elements, such as the rights to grant utility easements, licenses, or similar rights, including easements for cable television, under, through or over Common Elements as may be reasonably necessary to or desirable for the ongoing development or operation of the Condominium.

5.7 Easements in Units. To the extent that any utility line, pipe, wire or conduit serving any Unit shall be wholly or partially within the boundaries of another Unit, such other Units shall be burdened with and there hereby is reserved and created an easement for the use, maintenance, repair and replacement of such utility line, pipe, wire or conduit, such easement to run to the benefit of the Unit or Units served by the same.

5.8 Sales Office. The Declarant, its duly authorized agents, representative and employees shall have an easement for the maintenance of a sales offices and/or model Units on the Property so long as Declarant owns or occupies any Condominium Unit primarily for the purpose of sale. Such sales offices and/or model Units may be maintained in such number and size as determined by the Declarant and may be located and relocated in Units and/or in any improvements on the Common Elements. By execution hereof, the Declarant does hereby specifically reserve an easement for the use of the Common Elements as may be located within the Property as a sales and marketing office of the Declarant during the development of the Property, and for one (1) year after the last Condominium Unit located on the Property is sold, which easement shall be for exclusive use of the Common Elements unto the Declarant, to the exclusion of use of such Common Elements by any Owner. Exercise of the rights of such easement shall be by Declarant and its designates.

5.9 Easement for Improvements. Declarant shall have and does hereby reserve a transferable easement on and over the Common Elements for the purpose of making improvements contemplated by this Declaration on the Property, and for the purpose of doing all things reasonably necessary and proper in connection therewith.

5.10 Effect of Easements. All easements and rights herein established shall run with the land and inure to the benefit of and be binding on the Declarant, its successors and assigns, and any Condominium Unit Owner, Purchaser, mortgagee, or other Person having an interest in any portion of the Property herein described, whether or not such easements are maintained or described in any deed of conveyance.

5.11 Restoration of the Condominium. The benefited party of any easement granted hereunder shall have the duty and obligation to repair and restore the servient portion of the Condominium to the condition which existed prior to the exercise of such easement rights.

5.12 Declarant's Signage. Declarant shall retain the right to install and maintain a sign at all entrances to the Condominium which identifies the Condominium's association with the Declarant. This right shall continue for a period of two (2) years following the sale of the last Unit by Declarant to an Owner.

**ARTICLE VI
ARCHITECTURAL CONTROL COMMITTEE**

6.1 Committee Composition. There shall be a Architectural Control Committee (the "Committee"), which shall have the responsibility for governing the Units, Common Elements and related Limited Common Elements. The Committee shall consist of three (3) Persons who need not be Unit Owners.

6.2 Alternate Members. There shall also be one (1) alternate member for the Committee to be designated by the Declarant during the Period of the Declarant Control and thereafter by the Owners of the Units, to act as a substitute for any member of the respective Committee in the event of his or her unavailability or disability.

6.3 Appointment. The members of the Committee shall be selected as follows:

(a) Until the expiration of the Period of Declarant Control, Declarant shall have the right to appoint and remove all members and alternate members of the Committee. The Declarant may temporarily or permanently relinquish its right to appoint all or some of the Committee members and alternates at any time.

(b) After Declarant relinquishes its appointment rights or following the expiration of the Period of Declarant Control, the Committee shall be appointed by the members of the Board. The Committee shall, without further act or deed of the Declarant, exercise all rights of Declarant to enforce and implement the Development Guidelines and to perform Declarant's obligations under this Article and, at such time, all obligations of Declarant under this Article shall automatically terminate, and except as otherwise provided herein, all rights and obligations of Declarant under this Article shall vest in the Committee.

6.4 Terms of Office. The term of all Committee members and alternates appointed by Declarant shall be set by Declarant. The term of all Committee members and alternates appointed by the Unit Owners shall be two (2) years and shall have staggered terms as set forth in the Bylaws. Any new member appointed to replace a member who has resigned or been removed shall serve such member's unexpired term. Members whose terms have expired may be reappointed. A member of the Committee shall not be required to satisfy any particular qualifications for membership and may be a member of the Board, an officer of the Association, an officer or employee of Declarant or a Person who is not a member or Owner or Lessee or otherwise affiliated with the Condominium Property Regime.

6.5 Resignations; Vacancies. Any member of a Committee may, at any time, resign from the Committee upon written notice to Declarant, so long as Declarant has the sole right to appoint any member, or upon written notice to the remaining Committee members, and to the Board when the right to appoint any members is vested in the Board. Vacancies on a Committee of members appointed by Declarant, however caused, shall be filled by Declarant so long as Declarant has the right to appoint members. Vacancies on a Committee of members appointed by the Board, however, caused, shall be filled by the Board in the same manner set forth in Section 6.3, above.

6.6 Powers, Duties and Responsibilities. The Committee shall have the following power, duties and responsibilities with respect to the Units, Common Elements and the Limited Common Elements assigned and allocated to any one or more of the Units:

(a) all of the powers and authority conferred upon it by this Declaration and the Articles and the Bylaws;

(b) to hire and retain services of engineers or other consultants and professionals as they deem necessary to perform the duties of the Committee;

- (c) to perform the functions required of it by this Declaration;
- (d) to consider and act upon all Applications and the plans, specifications and other documents submitted to it pursuant to Article VII, below, with respect to decisions relating to the Units;
- (e) to adopt Development Guidelines;
- (f) to make and to enforce reasonable rules and regulations governing the use of the Units, Common Elements and Limited Common Elements;
- (g) to approve the relocation of the boundaries of any Unit or further subdivide or combine any one or more of the Units; and
- (h) to perform all other duties delegated to and imposed upon it by this Declaration and the Bylaws.

Notwithstanding the foregoing, only the Board shall determine the compensation, if any, to be paid to the members of the Committee.

6.7 Meetings. The Committee shall meet as often as it, in its sole discretion, shall deem necessary to properly perform its duties hereunder. The vote or written consent of any two members or designated alternates shall constitute an act by the Committee. The Committee shall keep written records of all actions taken by it.

6.8 Development Guidelines. In addition to any architectural and development standards set forth herein, the Committee may, from time to time, and in their reasonable discretion, draft, propose, adopt and amend Development Guidelines. Such Development Guidelines, and any amendments thereto, shall supplement, interpret and implement the provisions hereof by setting forth: (a) the standards and procedures for Committee review, and (b) guidelines for Improvements which shall include, but not be limited to, guidelines for architectural design of Improvements, floor plans, landscape plans, color schemes, signage, exterior lighting, finishes and materials for use in each portion of the Condominium. The Development Guidelines shall initially be adopted by the Declarant. After the expiration of the Period of Declarant Control, any amendment to the Development Guidelines must be approved by a majority vote of the Unit Owners with respect to any Development Guidelines established for the Unit Owners.

ARTICLE VII ARCHITECTURAL CONTROL AND REGULATION OF IMPROVEMENTS

7.1 Approval of Plans.

(a) Approval Required. Except for any Improvements constructed and installed by Declarant, no Improvement shall be constructed, erected, placed, expanded, added to, maintained or permitted to remain within the Condominium Regime (excluding

the interior of any Unit), and no alterations or other work which alters the exterior appearance of any Unit, Limited Common Element or Common Element, until the plans and specifications and other documentation as may be required by Development Guidelines for said Improvements and alterations, which may include without limitation floor plans, materials, colors, signage, exterior lighting and any other information needed to accurately describe the exterior appearance or functional characteristics of said Improvements (the "Application"), have been submitted to and approved in writing by the Committee. Three sets of the Application shall be filed with such Committee. Improvements approved in writing by Declarant prior to the recording of this Declaration shall be deemed to have been approved by the Committee.

(b) Filing Fee. As a means of defraying its expenses, each Committee may institute and require a reasonable filing fee to accompany the Application for each building or other construction project submitted. If resubmission of an Application is necessary, the Committee may require an additional filing fee.

(c) Governmental Regulations. All Applications for Improvements submitted to the Committee hereunder shall comply with any and all laws, rules, regulations or ordinances applicable to the Property which have been promulgated by any local, state, federal or other governmental agency or authority.

(d) Basis for Approval. The Committee shall have the right to disapprove the Application submitted to it, whether a preliminary or final submittal, if any part of it is:

- (i) not in accordance with this Declaration or the Development Guidelines or the Plans;
- (ii) incomplete;
- (iii) not in compliance with relevant approval requirements or regulations of local, state, federal or other governmental agencies;
- (iv) deemed by the Committee to be contrary to the best interests of the Condominium or the Owners; or
- (v) incompatible with the architectural style, quality or aesthetics of existing Improvements or development plans for proposed Improvements, based in part on the criteria set forth in subsections (w) through (z) below in this Subsection 7.1(d).

The Committee shall not unreasonably withhold its approval of an Application submitted to it. In this connection, the Committee may also base its approval or disapproval on criteria which may include, but are not limited to, the following: (w) conformity and harmony of external design with neighboring structures; (x) effect of location of proposed Improvements on the other Units within the Condominium; (y) adequacy of screening of trash facilities, storage areas, mechanical and heating and air-conditioning facilities and

rooftop installations; and (z) conformity of the Application to the purpose and general plan and intent of this Declaration. Any decision of the applicable Committee made after Declarant is no longer entitled to appoint the members of the Committee, may be appealed to the Board. The decision of the Board shall be final. As long as Declarant is appointing the members of the Committee, any decision of the Committee shall be final.

(e) Time for Decision. The Committee shall approve or disapprove each Application, whether a preliminary or final submittal, within thirty (30) days from the receipt thereof. If the Committee fails either to approve or disapprove the Application within said 30-day period; then it shall be deemed that the Committee has disapproved the Application. At least one set of the Application shall, with the approval or disapproval endorsed thereon, be returned to the submitting person and one set shall be retained by the Committee for its permanent files. Notwithstanding Section 7.1(a), no application or Notice shall be deemed filed with the Committee until it is actually received by at least one Committee member by certified mail (return receipt requested).

(f) Time for Commencing. Upon receipt of approval from each Committee pursuant to this Section and upon receipt of approvals from the City, the Owner shall, as soon as practicable, satisfy all conditions thereof and diligently proceed with the commencement and completion of all approved construction, refinishing, alterations, excavations and landscaping. In all cases, work shall be commenced within twelve (12) months of the date of such approval, or the approval given or deemed given pursuant to this Article shall be deemed revoked unless the Committee, upon request made prior to the expiration of said 12-month period, extends the time for commencing work by written notice to the Owner, which may be withheld or conditioned in the Committee's discretion.

(g) Completion of Work. All construction, refinishing, alteration or excavation of any Improvements approved under this Section 7.1 shall be undertaken and pursued diligently to completion, but in any event shall be completed within two years after the date of approval by the Committee. However, the time for completion shall be extended for any period such completion is rendered impossible or would result in great hardship due to strikes, fires, national emergencies, natural calamities or other similar supervening forces beyond the control of the Owner or its lessees. Failure to comply with this Subsection 7.1(g) shall constitute a breach of this Declaration and subject the defaulting party or parties to all enforcement procedures set forth herein or any other remedies provided by law or in equity.

(h) Disclaimer of Liability. Neither Declarant, the Committee nor any member thereof, nor any agents, officers or employees of Declarant or of the Committees, shall be liable in any way for any damage, loss or prejudice suffered or claimed by an Owner, Lessee or any other Person who submits an Application; except to the extent of actual damages arising directly from the bad faith acts or intentional misconduct thereof. Any person or entity who submits an Application shall forever defend, indemnify and hold the Declarant, the Committees, the members thereof, and the employees, officers and agents of each, harmless from all damage, loss or liability

(including reasonable attorneys' fees) suffered or claimed by any third party on account of (i) any defects in any plans, drawings, specifications or other documentation submitted in any Application, or revised or approved in accordance with the foregoing provisions, or for any structural or other defects in any work done according to such plans, drawings, specifications or other documentation; (ii) the approval or disapproval of any Application, whether or not defective; or (iii) the construction or performance of any work, whether or not pursuant to an approved Application, except to the extent of actual damages arising directly from the bad faith acts or intentional misconduct of the Declarant, a Committee or any member thereof, any agents, officers or employees of Declarant or of the Committee.

(i) No Representations or Warranties. In no event shall an approval by a Committee of any Application, or any written or oral statements made by the Board or any officer or employee of the Association, Declarant or any employee or officer or agent of Declarant, or the Committee or any member, agent or employee thereof, be deemed to constitute in any way any representations or warranties of any kind, express or implied, with regard to the Application and any plans, drawings, specifications or other documentation constituting a part of the Application, including without limitation representations or warranties regarding compliance with zoning, subdivision and land use laws, or compliance with any other applicable codes, regulations and laws, or with regard to fitness for a particular purpose.

(j) Presumption of Compliance; Estoppel Certificate. The foregoing notwithstanding, after the expiration of one (1) year from the date the Committee receives from an Owner either (i) a copy of the certificate of occupancy issued by the applicable governmental authority for any Improvement, or (ii) after an Improvement has been completed by an Owner and said Owner has delivered a valid notice of completion with respect to such Improvement to the Committee, then said Improvement shall, in favor of purchasers and encumbrances in good faith and for value, be deemed to be in compliance with the provisions of this Article VII unless a notice of non-compliance or non-completion with respect thereto has been executed by Declarant or the Committee and recorded in the office of the Register of Deeds of Douglas County, Nebraska or unless legal proceedings shall have been instituted to enforce compliance or completion with respect to said Improvement.

(k) Approval Cannot be Assigned. Any approvals given pursuant to this Article VII shall be personal to the Owner submitting the Application and cannot be assigned or transferred by such Owner without the prior written consent of the Board, which shall not be unreasonably withheld. Without such consent, any subsequent Owner of a Unit for which a previous Owner has obtained approval of an Application shall submit a new Application pursuant to this Section 7.1 for review and approval as though no prior approvals had been received from the Committee with respect to such Unit.

7.2 Variances. The Committee is hereby authorized and empowered to grant variances for Improvements or uses within the Condominium prohibited or regulated by this Declaration or the Development Guidelines and further to grant reasonable requests for relief

from the provisions of this Declaration, or any portion hereof, in order to overcome practical difficulties and to prevent unnecessary hardship in the application of the provisions contained herein. Notwithstanding the foregoing, the Committee shall not grant such a variance to any Owner unless:

- (a) such Owner has obtained all necessary governmental approvals,
- (b) the construction of Improvements or the uses which are called for under the request for the variance shall be consistent in design, character, appearance and quality of construction with the other Improvements and uses within the Condominium,
- (c) the variances do not materially injure, in the judgment of the Committee, any of the Units or Common Elements within the Condominium, and
- (d) the construction of Improvements and/or the uses called for under the request for variance are otherwise subject to and conform with all applicable laws, ordinances, rules and regulations, including, but not limited to, zoning regulations of any governmental agency or political entity having jurisdiction over the Condominium.

No variance granted pursuant to the authority granted herein shall constitute a waiver of any provision of this Declaration as applied to any other Person or portion of the Property, and the grant of a variance shall not obligate the Committee to grant other variances. In addition to the variance powers provided herein, the Committee shall be empowered to issue from time to time reasonable interpretations of the intent of the provisions of this Declaration or the Guidelines, which interpretations shall not constitute variances from the provisions of this Declaration, but shall be designed to further the implementation of this Declaration in a manner consistent with its provisions.

7.3 Maintenance During Construction. All construction activities of any kind on any portion of the Property shall be governed by the provisions of this Subsection and corresponding provisions in the Development Guidelines and the Plans. All construction activities shall be carried out in an orderly and timely manner and all partially completed Improvements shall be kept in an orderly condition during construction. If the provisions hereof conflict with the provisions of the Development Guidelines with respect to construction activities, the more restrictive provision shall control. Any repairs or replacements to the Common Elements, including any Limited Common Elements, necessitated by a Unit Owner's construction shall be performed by a contractor approved by the respective Committee having authority thereof.

ARTICLE VIII RESTRICTIONS

8.1 Permitted Uses - Units. Other than the Special Declarant Rights carried on by the Declarant or his assigns, agents or successors, during the Period of Declarant Control, the Units shall be restricted to single family residential use and may not be used for any other purpose. Nothing in this Section 8.1 is intended to prohibit an Owner from keeping his personal business or professional records or accounts therein, or handling his personal business calls or

correspondence therefrom.

8.2 Prohibited Uses - All Units, Common Elements and Limited Common Elements. In addition to all restrictions now existing against said Property and all Improvements now or hereafter constructed thereon, the use, occupancy and operation of the Units, Common Elements and including Limited Common Elements is hereby expressly restricted as follows:

(a) Animals. No animals, livestock, or poultry of any kind shall be raised, bred, or kept on any lot except that dogs, cats, or other household pets may be kept, provided that they are not kept, bred, or maintained for any commercial purposes. Each living unit shall be permitted to have no more than two (2) pets, such as one dog and one cat, two cats, or two dogs, provided, however, that no Pit Bull Terriers or Rottweilers shall be allowed in any case. No one pet shall be allowed which weighs more than forty-five (45) pounds, and no combination of pets shall be allowed in any Unit which total more than thirty-five (45) pounds. In the event that any amendments are made to this Declaration which further restrict the keeping of pets, all pets that had existed at the time of such amendment shall be "grandfathered" and shall be allowed to remain in the Living Unit, provided, however, that no replacement pets acquired after the date of the amendment would be allowed if they violate any such amendment. All pets must be kept on a leash and each Owner shall be responsible for cleaning up any waste or mess made by the pet. Any damage done by pets including dragging chains, digging, scratching or chewing, shall be the responsibility of the owner of such pet, including, but not limited to, any damage done to landscaping. The Association shall have the right to require removal of pets in the individual cases where such pets are or become legal nuisances and unreasonably disturb the quiet enjoyment of the Properties by the Owners. The Association may levy a \$25.00 per incident charge for any pet waste that is not cleaned up by the owner of such pet.

(b) Use of Property. Except for the right of ingress and egress, the Owners of Units are hereby prohibited and restricted from using any property outside of their respective Units, except as may be allowed by the Association's Board of Directors or as expressly provided herein. It is expressly acknowledged and agreed by all parties concerned that this paragraph is for the mutual benefit of all Owners within the Condominium Regime and is necessary for the protection of the Owners.

(c) Antennas. No television antenna or radio receiver, satellite dish, or other similar device shall be attached to or installed on any portion of the Property, unless contained entirely within the interior of a Unit, or on the roof of the Unit; provided, however, any such installation on the roof of the Unit shall be approved in writing by the Board and performed by the Association's contractor at the Unit Owner's expense. In the event that any installation under this section shall require a roof penetration, such roof penetration shall be performed by a roofing contractor approved by the Board. No radio or television signals, nor any other form of electromagnetic radiation shall be permitted to originate from any Unit which may unreasonably interfere with the reception of television or radio signals within the Condominium Project; provided, however, that Declarant and the Association shall not be prohibited from installing equipment

necessary for the operation of any master antenna, security, cable television, mobile radio, or other similar systems within the Condominium Project.

(d) Vehicles, Etc. No vehicles shall be parked on the Common Elements, other than in authorized Parking Spaces, and no vehicle repairs, other than emergency repairs or repairs of a minimal nature needed to be performed to move a vehicle off the Property, shall be allowed on the Property. No vehicles shall be parked or stored on blocks or other such devices on the Common Elements or any other portion of the Condominium Project. No vehicles shall be parked so as to obstruct the fire lanes or roadways as may exist within the Condominium. The Association is expressly authorized to tow away, at an offending Owner's expense, any vehicle which is in violation of this Section, or which is placed on the Condominium Property in violation of the rules and regulations governing parking as may be adopted by the Board of Directors. No boats, boat trailers, campers, canoes, recreational vehicles, vehicles used primarily for recreational purposes, vehicles primarily used for commercial purposes, or vehicles with commercial writings on their exterior shall be stored, allowed to remain, or parked on any portion of the Condominium, except in an area, if any, designated by the Board of Directors or except as otherwise permitted by the Association's Board of Directors or Declarant. The Board shall have the right to designate areas within the Condominium Project for the parking of motorcycles and bicycles.

(e) Signs. Except as placed or erected by Declarant or his assigns, agents or successors, no signs, billboards or objects shall be erected, placed, or permitted to remain on the Property, nor shall such Property be used in any way or for any purpose which may endanger the health or unreasonably disturb the Owner of any Unit. No Unit Owner shall display a "for rent" or "for sale" sign without the express written consent of the Board.

(f) Miscellaneous Prohibited Uses. No Unit shall be occupied, operated or maintained in an unsanitary or hazardous condition.

8.3 Security and Frozen Pipes. Should a Unit become vacant, the Owner is responsible for securing the Unit while it is unoccupied, including engaging all locks, providing security lighting, and heating the interior sufficient to keep pipes from freezing. Insurance claims or costs incurred by the Association or the Board for frozen pipe damage in unheated Unit may be offset by a special assessment levied against the Unit in an amount equal to the damage claim.

8.4 Unightly Appearances. No offensive or unightly appearance shall be maintained or allowed to exist on those portions of any Unit visible from the exterior of the Condominium or Common Areas i.e. halls, etc. All equipment, garbage cans, and storage areas shall be kept in a manner so as to conceal them from view of neighboring Units and streets, unless otherwise authorized by the Association's Board of Directors; provided, however, exterior personal patio furnishings, such as chairs, grills and swings, located within a Unit's balcony, patio, porch, terrace, or deck shall be permissible, subject to the rules and regulations of the Association. Provided further, however, that nothing shall be permitted which in the opinion of

the Association's Board of Directors jeopardizes the structural integrity of any deck or other part of the Condominium, or which presents risk of damage to adjacent property shall be permitted.

8.5 Acts Affecting Insurance. An Owner shall not permit or suffer anything to be done or kept in his or her Unit which will increase the rate of insurance acquired by the Association or which will otherwise obstruct or interfere with the rights of other Owners.

8.6 Trash Containers and Collection. No garbage or trash shall be placed or kept on the Condominium except in covered containers of a type, size and style which are approved by the Association. The Association shall have the right to subscribe to a trash service for the use and benefit of the Association and all Owners; and to adopt and promulgate rules and regulations regarding garbage, trash, trash containers and collection. The Association shall have the right to require all Owners to place trash and garbage in containers located in areas designated by the Association. No incinerators shall be kept or maintained in any Unit. All rubbish, trash, and garbage shall be regularly removed from the Property and shall not be allowed to accumulate thereon. If trash dumpsters are used to facilitate trash, rubbish and garbage removal, all such trash, rubbish and garbage shall be placed therein for removal from the Property.

8.7 Machinery and Equipment. No machinery or equipment of any kind shall be placed, operated or maintained upon the Condominium except such machinery or equipment as is usual and customary in connection with the Declarant's sales, marketing, maintenance or construction of the Improvements which are within the permitted uses of such Property, and any use except that which Declarant or the Association may require or permit for the operation and maintenance of the Common Elements and Units.

8.8 Leasing of Units. A Unit Owner may lease his or her Unit and/or garage (but not less than his or her entire Unit) from time to time provided that:

- (a) The initial terms of any lease shall be for a period of not less than six (6) months;
- (b) No Unit may be leased or subleased without a written lease or sublease;
- (c) A fully executed copy of such lease or sublease shall be furnished to the Board for approval not less than thirty (30) days prior to the date the lessee or sublessee obtains possession of the Unit;
- (d) The rights of any lessee of a Unit shall be subject to, and each such lessee shall be bound by, the covenants, conditions and restriction set forth in the Declaration, Bylaws and Rules and Regulations, and a default thereunder shall constitute a default under the lease or sublease; provided, however, that the foregoing shall not impose any direct liability on any lessee or sublessee of a Unit to pay any Common Expenses or special assessments on behalf of the Owner of that Unit.

Notwithstanding the foregoing, the provisions of Section 8.8 shall not apply to a holder of a Eligible Mortgage who is in possession of a Unit following a default in such mortgage, a

foreclosure proceeding or any deed or other arrangement in lieu of foreclosure.

8.9 Lawful Use. No improper or unlawful use shall be permitted on any part of the Condominium. All valid laws, zoning ordinances, and regulations of all government bodies having jurisdiction over the Condominium shall be observed. Any violation of such laws, zoning ordinances or regulations shall be a violation of this Declaration.

8.10 Nuisances and Offensive Activity. No Owner, lessee, occupant, or other Person shall create a nuisance within the Condominium Regime, or use any portion of the Condominium Regime for any activity or purpose which is considered by the Board, its sole and absolute discretion, to be objectionable due to sound, odor, visual effect or physical impact and which in the opinion of the Board will disturb or tend to disturb other Owners or lessees in the Condominium, or which is deemed by the Board to constitute a nuisance. Included among the uses or activities prohibited because of their detrimental effect upon the general appearance, enjoyment and use of the Condominium are, without limitation, the following:

- (a) Any public or private nuisance.
- (b) Any vibration, noise, sound or disturbance that is objectionable due to intermittence, beat, frequency, shrillness, loudness or pulsating effect.
- (c) Any lighting which is flashing or intermittent or is not focused downward or away from any Unit within the Condominium, unless otherwise approved by the Board.
- (d) Any air pollution, including without limitation any dust, dirt, mold, microbials or other environmental pollutants in excessive quantities.
- (e) Any emission of excessive, offensive, or noxious odors.

No nuisance shall be permitted to exist or operate upon the Condominium and no activity shall be conducted upon the Condominium which is offensive or detrimental to any portion of the Condominium or any Owner or Occupants of the Condominium. No exterior speakers, horns, whistles, bells or other sound devices except security or other emergency devices used exclusively for security or emergency purposes shall be located, used or placed on or in the Condominium Project.

8.11 Enforcement. This Declaration, including all restrictions set forth herein, and the rules and regulations may be enforced by injunctive relief, specific performance or the imposition of reasonable monetary fines as provided in the Act and suspension of use and voting privileges. These powers, however, shall not be construed as limiting any other legal means of enforcing the use restrictions or rules and regulations of the Association. Any fines so imposed shall be considered an assessment against the Unit and may be collected in the manner provided for collection of other assessments. In addition to the foregoing, if any Person shall fail to maintain its Unit in a reasonably safe and sanitary condition, the Association may, at the Board's option, and after ten (10) days written notice to the Unit Owner, perform any clean-up, repair

and/or replacement to cure any such condition, and all cost and expenses reasonably incurred by the Association, plus interest thereon at the rate of sixteen (16%) per annum, shall be reimbursed to the Association by such Unit Owner within thirty (30) days after work has been completed. The Association may levy a special assessment against any such Unit, which may be enforced in accordance with Section 10.9, below.

**ARTICLE IX
MAINTENANCE**

9.1 Maintenance of Condominium Units and Limited Common Elements.

(a) By the Owner. Except as provided in subsection (b) of this Section, each Owner shall have the obligation to maintain, keep attractive, keep in good repair, and replace (subject to applicable and available insurance proceeds) all portions of the Unit and any Limited Common Elements exclusively allocated to such Unit. Any maintenance, repair, replacement or upkeep required to be performed by an Owner hereunder shall be in conformance with the architectural standards as set forth by the Board. In explanation of the foregoing and not to be construed as a limitation, each Owner shall maintain, repair, and keep in good condition (subject to the Association's obligations hereinafter set forth), his or her Unit.

(b) By the Association. The Association shall maintain, keep in good repair and upkeep, and replace (subject to available insurance proceeds), as a Common Expense assessed in accordance with this Declaration, all of the Condominium property not required to be maintained and kept in good order by a Unit Owner and as otherwise set forth in this Section. The Association shall, by way of explanation and not limitation, be responsible to maintain, keep attractive, keep in good repair and replace all of the Common Elements. The Association shall, also, be responsible for the repair, upkeep and maintenance of all roofs and foundations in respect to Improvements containing the Units or otherwise, and shall further be responsible for the maintenance, repair and replacement of any deck, patio, or stoop attached to any Unit. In the event the need for maintenance, repair or replacement which is the responsibility of the Association hereunder is caused through the willful or negligent act of an Owner, his or her family, guests, lessees, or invitees, then, the Association shall give the Owner written notice of the repair, replacement or maintenance work needed and an estimated cost to accomplish such repair, replacement or maintenance work. The Owner shall have fifteen (15) days within which to pay the Association such estimated costs, and in the event of a failure to pay, such costs shall be added to and become a part of the assessment to which such Owner is subject and shall become a lien against the Unit. Despite any provision herein contained to the contrary, the Association shall not be liable for injury or damage to any Person or property: (i) caused by the elements or by any Unit Owner or by any other Person; (ii) resulting from any rain, water, snow or ice which may leak or flow from any portion of the Common Elements; or, (iii) caused by the leaking, failure or disrepair of any pipe, plumbing, drain, conduit, appliance, equipment or utility lines or facilities, the responsibility for the maintenance of which belongs to the Association. In addition, the Association shall be responsible for the maintenance of sewer lines within the Units as

extended from each Unit to the main sewer line connecting to the Condominium Property.

(c) Failure to Maintain. If the Board of Directors of the Association determines that any Owner has failed or refused to discharge his or her obligations with regard to the maintenance, repair, upkeep or replacement of any items for which he or she is responsible hereunder, including, but not limited to, a failure to maintain, repair or replace a condition which may increase the possibility of fire or other loss or damage to the Condominium, then the Association (except no notice shall be required in an emergency situation in which case the Association may proceed immediately) shall provide the Unit Owner with written notice specifying the nature of the maintenance, repair or replacement and the estimated costs thereof with reasonable particularity. The Owner shall have fifteen (15) calendar days to complete any such repairs, maintenance or replacements; provided, however, the Unit Owner shall have more than fifteen (15) days if such performance cannot reasonably be completed within fifteen (15) days and the Unit Owner is diligently pursuing the completion. In the event the Owner fails, neglects or refuses to repair, maintain or replace any such items within fifteen (15) days after the receipt of the notice, then the Association, through its Board, shall have the right to cause the repairs, maintenance or replacements to be made, and the Unit Owner shall, within thirty (30) days after the completion of such work, reimburse the Association. In the event any such repair or replacements are to the Common Elements the Association shall complete all such work, and the Unit Owner responsible for such repairs, maintenance or replacements shall have thirty (30) days after demand is made to reimburse the Association. Any costs incurred by the Association under this Section shall be special assessments and shall be added to and become a part of the assessment to which such Owner is subject and shall become a lien against the Unit.

ARTICLE X ASSOCIATION AND BYLAWS, ASSESSMENTS

10.1 General Information. The Association will administer the Condominium pursuant to the terms and conditions set forth in this Declaration and the Bylaws. The fiscal year of the Association shall be the calendar year. The Office of the Association shall be located at such location as the Board of Directors or the Managing Agent shall designate from time to time. The Association shall be required at all times to employ a Managing Agent. All Unit Owners, by virtue of their ownership of a Unit in the Condominium, are automatically mandatory Members of the Association and shall be entitled to vote on all matters upon which Members of the Association are entitled to vote, pursuant to this Declaration and in accordance with the Bylaws. The foregoing is not intended to include persons or entities who hold an interest merely as security for the performance of an obligation. Subject to the provisions of the Condominium Documents, the Owner or Owners of each Unit shall be entitled to one (1) vote for such Unit in which the interest required for membership is held. Each Unit is allocated a vote equal in weight to each other Unit. Provided however, if a Unit Owner shall have, in the sole opinion of the Board, an unresolved financial delinquency with respect to the Association, such Owner's vote shall not be eligible and shall not be entitled to be cast or counted.

10.2 Meetings and Voting. Annual and Special Meetings of the Association, including all notice and quorum requirements and voting of the membership shall be set forth in the Bylaws.

10.3 Directors. During the Period of Declarant Control, the business of the Association shall be managed by a Board of Directors comprised of at least three (3) Directors who shall be appointed by the Declarant and shall serve without compensation. During the Period of Declarant Control, during which time fewer than seventy-five percent (75%) of Units have been conveyed, the Declarant shall have the power to appoint all Directors and Officers of the Association. The qualification, election, term, removal, resignation and replacement of each Board member shall be determined in accordance with the Bylaws. The Declarant may voluntarily surrender the right to appoint and remove officers and members of the Board before termination of the foregoing. In that event, the Declarant may require, during the Period of Declarant Control, that the actions of the Association or Board of Directors, as might be described in a recorded instrument executed by Declarant, be approved by the Declarant before they become effective. At end of the Period of Declarant Control, the membership of the Board shall always be comprised of five (5) Persons. Nothing in this section 10.3 or elsewhere in the Covenants is intended to discourage the solicitation of Owner input to the Declarant and the Board of Directors during the Period of Declarant Control.

10.4 Director's Meetings. Regular and Special Meetings of the Board of Directors, including the notice and quorum requirements and voting of the Board, shall be set forth in the Bylaws.

10.5 Powers and Duties of the Board of Directors. All of the powers and duties of the Association existing under the Act, the Declaration and the Bylaws shall be exercised by the Board of Directors, its duly appointed agents, contractors or employees, subject only to approval by the Unit Owners where specifically required. Compensation of employees of the Association shall be fixed by the Directors. A Director may be an employee of the Association and a contract for management of the Condominium may be entered into with a Director or the Declarant.

10.6 Officers. The executive officers of the Association shall consist of a President, who must also be a Director, a Vice-President, Treasurer, and Secretary. The Bylaws shall provide for: (i) the election of officers; (ii) the resignation; (iii) removal; (iv) vacancy; and (v) powers, duties and responsibilities of the officers of the Association.

10.7 Assessments.

(a) All Owners shall be obligated to pay the estimated assessments imposed by the Board of Directors of the Association to meet the Common Expenses. The Common Expenses of the Association shall be assessed among all of the Condominium Unit Owners in accordance with the Owner's share in the Common Elements or Limited Common Elements as set forth in Article III of this Declaration. Assessments for the estimated Common Expenses of the Association shall be due in advance of the first day of each calendar month or less frequently as may be determined by the Board of

Directors.

(b) Each Unit Owner's obligation of payment of assessments shall begin on the day which title to the Unit is transferred to such Unit Owner.

(c) In the event the ownership of a Condominium Unit, title to which is derived from Declarant, commences on a day other than the first day of the assessment period, the assessment for that period shall be prorated.

(d) Assessments shall be based upon the cash requirements deemed to be such aggregate sum as the Board of Directors of the Association shall from time to time determine and is to be paid by all of the Condominium Unit Owners to provide for the payment of all estimated expenses growing out of or connected with the maintenance, repair, operation, additions, alterations and improvements of and to the Common Elements and those Limited Common Elements which are the responsibility of the Association, and the Property and Improvements owned thereby, which sum may include, but shall not be limited to: management fees, expenses and liabilities incurred by the Managing Agent, taxes and special tax assessments (unless and until separately assessed), snow removal, road and sidewalk repair, premiums for insurance, landscaping and care of grounds, repair, maintenance and replacement of decks, patios and stoops, common lighting, repairs and renovation, trash and garbage collections, wages, common water and sewer charges, legal and accounting fees, management fees, expenses and liabilities incurred by the Managing Agent, if any, on behalf of the Unit Owners under or by reason of the Declaration or the Bylaws of the Association for the creation of a reasonable contingency, reserve, working capital and sinking funds as well as other costs and expenses relating to the Common Elements or Limited Common Elements which are the responsibility of the Association.

(e) Pursuant to the provisions of the Declaration and the Bylaws, the Board of Directors may levy assessments for the purpose of creating a reserve fund to defray the cost of repair or reconstruction of the Improvements in the event of their damage.

(f) The Association by its Board of Directors may levy a special assessment against any individual Unit or any Unit Owner for the reasonable expense incurred in the reconstruction or repair to the Common Elements, Limited Common Elements or the individual Unit for damage or destruction caused by the misconduct, negligence or infraction of the published rules and regulations of the Association by the Unit Owner or his guests, invitees.

(g) The omission or failure to fix the assessment or deliver or mail a statement for any period of time shall not be deemed a waiver, modification or release of the Owner's obligation to pay the same.

(h) The Board shall, pursuant to Section 76-844(c) of the Act, have the power and authority to assess any Common Expenses benefiting fewer than all of the Units exclusively against the Units benefited thereby as contemplated in the Act.

(i) The Association shall have all of the powers of the Association enumerated in the Act.

(j) Within thirty (30) days after adoption of any proposed budget for the Condominium, the Board of Directors shall provide a summary of the budget to all the Unit Owners, and shall set a date for a meeting of the Unit Owners to consider ratification of the budget, which date shall not be less than fourteen (14) no more than thirty (30) days after mailing of the summary. Unless at that meeting a majority of all the Unit Owners, reject the budget, the budget is ratified, whether or not a quorum is present. In the event the proposed budget is rejected, the periodic budget last ratified by the Unit Owners shall be continued until such time as the Unit Owners ratify a subsequent budget proposed by the Board of Directors.

10.8 Owner's Personal Obligation for Payment of Expenses. The amount of the Common Expenses assessed by the Association against each Condominium Unit shall be the personal and individual debt of the Owner thereof. No Owner may exempt themselves from liability for this contribution towards the Common Expenses by waiver of the use or enjoyment of any of the Common Elements, the real property and Improvements owned by the Association or by abandonment of their Unit. The Board of Directors shall have the responsibility to take prompt action to collect any unpaid assessments which remain unpaid for more than ten (10) days from the date for payment thereof. The failure to make payment of any assessments or installment thereof related to any Unit before the tenth (10th) day after the due date shall constitute a default and such Unit Owner shall: (a) pay a late charge of five (5%) percent on the outstanding balance; and (b) all amounts that are delinquent shall bear interest from the due date at a rate equal to sixteen (16%) percent per annum or the maximum interest rate allowed by law, whichever is less, and all costs and expenses incurred by the Board or its authorized representative in the collection of the amounts, including reasonable attorneys' fees and costs, shall be part of the assessment past due and the full assessment shall be a lien against such Unit. Suit to recover a money judgment for unpaid Common Expenses shall be maintainable without foreclosing the lien nor shall such suit be construed to be a waiver of the lien.

10.9 Association Lien for Non-Payment of Common Expenses.

(a) All sums assessed by the Association but unpaid for the share of Common Expenses chargeable to any Condominium Unit shall constitute a lien on such Unit superior to all other liens and encumbrances, except for (i) taxes and special assessment liens of the Condominium Unit in favor of any assessing entity, and (ii) all sums unpaid on an Eligible Mortgage of record, including all unpaid obligatory sums as may be provided by such encumbrances. To evidence such lien, the Board of Directors shall prepare a written notice of lien assessment setting forth the amount of such unpaid indebtedness, the amount of the accrued interest and late charges thereon, the name of the Owner of the Condominium Unit and a description of the Condominium Unit. Such notice of lien shall be signed by one of the members of the Association's Board of Directors or by one of the officers of the Association on behalf of the Association and shall be recorded in the Office of the Register of Deeds of Douglas County, Nebraska.

Such lien shall attach and be effective from the due date of the assessment until all sums, with interest and other charges thereon, shall have been fully paid.

(b) Such lien may be enforced by the foreclosure of the defaulting Owner's Condominium Unit by the Association in the manner of a deed of trust or mortgage on real property upon the recording of a notice of claim thereof. In any such proceedings, the Owner shall be required to pay the costs, expenses and attorney's fees incurred for filing the lien, and in the event of foreclosure, all additional costs, all expenses and reasonable attorney's fees incurred. The Owner of the Condominium Unit being foreclosed shall be required to pay the Association the monthly assessment for the Condominium Unit during the period of foreclosure, and the Association shall be entitled to a receiver during foreclosure. The Association shall have the power to bid on the Condominium Unit at foreclosure or other legal sale and to acquire and hold, lease, mortgage, vote the votes appurtenant to, convey and otherwise deal with the same.

(c) Any Qualified Lender holding a lien on a Condominium Unit may pay, but shall not be required to pay, any unpaid Common Expenses payable with respect to such Unit, and upon such payment, such Qualified Lender shall have a lien on such Unit for the amount paid of the same rank as the lien of its mortgage or encumbrance without the necessity of having to record a notice of claim of such lien. The Association shall report to the Qualified Lender of a Condominium Unit any assessments remaining unpaid for longer than sixty (60) days after the same are due; provided, however, that a Qualified Lender shall have furnished to the Association notice of its encumbrance.

(d) The recorded lien may be released by a Release of Lien signed by one of the members of the Association's Board of Directors or by one of the officers of the Association on behalf of the Association and recorded in the Office of the Register of Deeds of Douglas County, Nebraska.

(e) Notwithstanding any of the foregoing provisions, any Qualified Lender who obtains title to Condominium Unit pursuant to the remedies set forth in its mortgage or deed of trust shall take title to the Unit free and clear of all Common Expense assessments levied thereon prior to such transfer of title and free and clear of all liens created as a result of such assessments.

10.10 Ascertainment of Unpaid Common Expenses.

(a) The Unit Owners and their mortgagees, prospective mortgagees or prospective grantees, upon ten (10) days written notice to the Board of Directors and upon payment of a reasonable fee, shall be furnished a statement of their account. The statement of account shall include the amount of any unpaid Common Expenses, the amount of the current assessments, the dates that assessments are due, the amount for any advanced payments made, prepaid items such as insurance policy premiums and reserves therefor and any deficiencies in reserve accounts such statement shall be conclusive upon the Association in favor of all persons who rely therein in good faith. Unless such request shall be complied with within twenty (20) days after receipt of such written

request, all unpaid Common Expenses which become due prior to the date of such request will be subordinate to the rights of the Qualified Lender requesting such statement.

(b) The provisions set forth in this Section shall not apply to the initial sales and conveyances of the Condominium Units made by Declarant, and such sales shall be free from all unpaid Common Expenses to date of conveyance made or to a date as agreed upon by Declarant and Declarant's grantee.

10.11 Priorities of Association and Recreational and Maintenance Association Lien for Common Expenses. The Owner of a Condominium Unit may create junior deeds of trust or mortgages junior to the lien, deed of trust or other encumbrances of an Eligible Mortgage or other liens or encumbrances of the Condominium Unit; provided, however, that any such junior mortgage, deed of trust, lien or encumbrance will always be subordinate to the prior and paramount lien of the Association for Common Expenses, and subject to all of the terms, conditions, covenants, restrictions, uses, limitation and obligations under this Declaration and the Bylaws, and, provided, further, that the holder of any such junior encumbrance shall release its security interest in any Unit for the purposes of restoring any Improvements upon the encumbered Condominium Unit and all of the Unit Owner(s) rights, title and interest in and to the proceeds under all insurance policies upon said premises by the Association. Such release shall be furnished forthwith by a junior mortgagee upon written request of the Association, and if such request is not granted, such release may be executed by the Association as attorney-in-fact for such junior mortgagee.

10.12 Financial Statements. The Board of Directors of the Association may hire an accounting firm to prepare audited financial statements for each fiscal year, or may prepare or have prepared unaudited financial statements. The financial statement for the proceeding fiscal year shall be available to the holder, insurer, or guarantor of any mortgage that is secured by a Unit in the Condominium Project on submission of a written request therefore. The financial statements must be available within one hundred twenty (120) days of the Association's fiscal year end.

ARTICLE XI INSURANCE AND CONDEMNATION

11.1 Scope of Coverage. Commencing not later than the date of the first conveyance of a Unit to a Purchaser, the Association shall maintain, to the extent reasonably available, the following insurance coverage:

(a) Property insurance on the Common Elements, Limited Common Elements and Units, exclusive of any improvements and betterments installed in Units by the Owners thereof, and other than the original improvements and betterments installed or constructed within any Unit by the Declarant (which shall be covered by the Association's insurance), insuring against all risk of direct physical loss commonly insured against in an amount equal to the maximum insurable replacement value of the Common Elements, Limited Common Elements and Units, as determined by the Board of

Directors; provided, however, that the total amount of insurance after application of any deductibles shall not be less than one hundred percent (100%) of the current replacement cost of the insured property, exclusive of land, excavations, foundations and other items normally excluded from a property policy.

(b) Comprehensive general liability insurance, including medical payments insurance, in an amount determined by the Board of Directors, but not less than One Million Dollars (\$1,000,000.00) per injury or injuries, including death, arising out of a single occurrence, and Fifty Thousand Dollars (\$50,000.00) property damage; or, in the alternative, a liability policy affording coverage for bodily injury and property damage with a combined single limit in an amount not less than One Million Fifty Thousand Dollars (\$1,050,000.00). The policy or policies shall cover the Association, the Association's Board of Directors and the officers of the Association, committee members, all agents and employees of the Association and all Owners and other Persons entitled to occupy any Unit or other portion of the Condominium Unit for occurrences commonly insured against, arising out or in connection with the use, ownership or maintenance of the Common Elements, Limited Common Elements, or other portion of the Condominium which the Association has the responsibility to maintain and shall also include hired automobile and non-owned automobile coverage with cost liability endorsements to cover liabilities of the Owner.

(c) Fidelity bonds shall be obtained by the Managing Agent covering all employees and agents of the Managing Agent in an amount which shall exceed the actual funds to which the Managing Agent has access or an amount equal to three (3) months of assessments to all Units, whichever is greater. The Association may obtain fidelity bonding separate from that of the Managing Agent for any officers, directors, employees and agents of the Association having access to Association funds. Any fidelity bonds obtained must require that the Association be notified of any cancellation in coverage not less than ten (10) days prior to such cancellation being effective.

(d) Such other insurance as the Association shall determine from time to time to be appropriate to protect the Association or the Owners.

(e) The insurance policies purchased by the Association, to the extent reasonably available, shall contain the following provisions:

(i) Each Owner shall be an insured under the policy with respect to liability arising out of his ownership of an undivided interest in the Common Elements or their membership in the Association.

(ii) There shall be no subrogation with respect to the Association, its agents, servants, and employees, or with respect to the Owners and members of their household. Each party hereby waives, releases and discharges any right of subrogation against the other for any loss arising out of damage to or destruction of all or any portion of the Property or contents thereof when such loss is caused by any perils included within either party's insurance provisions.

(iii) No act or omission by any Owner, unless acting within the scope of their authority on behalf of the Association, shall void the policy or be a condition to recovery on the policy.

(iv) The coverage afforded by such policy shall not be brought into contribution or proration with any insurance which may be purchased separately by Owners or their mortgagees or beneficiaries under deeds of trust.

(v) A "severability of interest" endorsement which shall preclude the insurer from denying the claim of an Owner because of the negligent acts of the Association or other Owners.

(vi) Statement of the name of the insured as Stone Creek Village Condominium Association, for the use and benefit of the individual Owners (designated by name if required by the insurer).

(vii) For policies of hazard insurance a standard mortgagee clause providing that the insurance carrier shall notify the Qualified Lender named in the policy at least ten (10) days in advance of the effective date of any reduction or cancellation of the policy.

(viii) "Agreed Amount" and "Inflation Guard" endorsements.

It shall be the duty of the Board at least annually to conduct an insurance review to determine if the policy enforced is adequate to meet the need of the Association and to satisfy the requirement of this Declaration and the Act. Such responsibility may be performed and shall be deemed reasonably performed, by the Board's Managing Agent requesting the Association's insurance agent to verify that the insurance policies in existence meet the needs of the Association as set forth herein and satisfies the requirements of this Declaration and the Act. In all events, each Owner shall have the right to obtain additional coverage for such improvements, or betterments or personal property within the Unit as its own expense. Each policy may contain reasonable deductibles and the amount thereof shall be added to the face amount of the policies in determining whether the insurance equals at least full replacement cost.

11.2 Certificate of Insurance. An insurer that has issued an insurance policy under this Article shall issue certificates or a memorandum of insurance to the Association and, upon request, to any Owner, mortgagee or beneficiary under a deed of trust. Any insurance obtained pursuant to this Article may not be canceled until thirty (30) days after notice of the proposed cancellation has been mailed to the Association, each Owner and each Qualified Lender who is listed as a scheduled holder of a Eligible Mortgage in the insurance policy.

11.3 Payment of Premiums. Premiums for all insurance obtained by the Association pursuant to this Article shall be Common Expenses and shall be paid for by the Association.

11.4 Insurance Obtained by Owners. The issuance of insurance policies to the

Association pursuant to this Article shall not prevent an Owner from obtaining insurance for their own benefit and at their own expense covering their Unit, personal property and providing personal liability coverage.

11.5 Payment of Insurance Proceeds. Any loss covered by property insurance obtained by the Association in accordance with this Article shall be adjusted with the Association and the insurance proceeds shall be payable to the Association and not to any mortgagee or beneficiary under a deed of trust. The Association is empowered to act as attorney-in-fact to conduct any negotiation, settlement or pursuit of insurance proceeds on behalf of the Owners. The Association shall hold any insurance proceeds in trust for Owners and lienholders as their interests may appear. Subject to the provisions of Section 11.6 and 11.7 of this Article, the proceeds shall be disbursed for the repair or restoration of the damage to Common Elements, Limited Common Elements and Units. Owners and lienholders shall not be entitled to receive payment of any portion of the proceeds unless there is a surplus of record after the Common Elements, Limited Common Elements and Units have been completely repaired or restored, or the Declaration terminated.

11.6 Use of Insurance Proceeds. In the case of fire or any other casualty, the insurance proceeds, if sufficient to reconstruct any Improvements so damaged or destroyed, shall be applied to such reconstruction. Reconstruction of the Improvements, as used herein, means restoring the insured Improvements to substantially the same condition in which it existed prior to the fire or other disaster, with each Unit and the Common Elements having the same vertical and horizontal boundaries as before.

11.7 Procedure where Insurance Proceeds are Insufficient. In case of fire or other casualty, if the insurance proceeds are insufficient to reconstruct the Improvements and the Condominium Unit Owners and all other parties in interest do not voluntarily make provision for reconstruction of the Improvements within 180 days from the date of damage or destruction, the Association may record a notice setting forth such facts; and upon the recording of such notice:

(a) The Property shall be deemed to be owned as tenants-in-common by the Condominium Unit Owners;

(b) The undivided interest in the Property owned in common of each Condominium Unit Owner shall be the percentage of undivided interest previously owned by such Unit Owner in the Common Elements.

(c) Any liens affecting any of the Condominium Units shall be deemed to be transferred in accordance with the existing priorities to the undivided interest of the Condominium Unit Owner in the Property as provided herein; and

(d) The Property shall be subject to an action for partition at the suit of any Condominium Unit Owner, in which event the net proceeds of such sale, together with the net proceeds of the insurance on the Property, if any, shall be considered as one fund, and shall be divided among all the Condominium Unit Owners in a percentage equal to the percentage of undivided interest owned by each Unit Owner in the Property, but only

after first paying out of the respective share of each Condominium Unit Owners, (to the extent sufficient for the purpose) all liens on the undivided interest in the Property owned by such Condominium Unit Owner.

11.8 Insurance Deductibles. If maintenance is required as a result of an insured loss, the amount of the deductible shall be considered a maintenance expense to be paid by the Person or Persons who would be responsible for such repair in the absence of insurance. If the loss affects more than one (1) Unit, or a Unit and Common Elements, the cost of the deductible may be apportioned equally by the Board of Directors among the parties suffering loss in accordance with the total cost of repair.

11.9 Condemnation. The Association shall represent the Unit Owners in any condemnation proceedings or in negotiations, settlements, and agreements with the condemning authority for acquisition of the Common Elements, or any part thereof, by the condemning authority. The Association is empowered to act as attorney-in-fact for the Owners for such purposes. In the event of a taking or acquisition of a part or all of the Common Elements by a condemning authority, the award or proceeds of a settlement shall be payable to the Owners Association to be held in trust for Unit Owners and the holders of Eligible Mortgages as their interest may appear.

11.10 Settlement as Proceeds. For the purposes of this Article XI, the proceeds of any insurance settlement shall be deemed as insurance proceeds. The proceeds of any sale of any part of the Condominium Project made under threat of condemnation shall be deemed as condemnation proceeds.

ARTICLE XII MORTGAGES

12.1 Requirements.

(a) Any mortgage or other lien on a Unit and the obligations secured thereby shall be deemed to provide, generally, that the mortgage or other lien instrument and the rights and obligations of the parties thereto shall be subject to the terms and conditions of the Act and this Declaration and shall be deemed to provide specifically, but without limitation, that the mortgagee or lien holder shall have no right (i) to participate in the adjustment of losses with insurers or in the decision as to whether or not, how to repair or restore damage to or destruction of the Property, or (ii) to receive or apply the proceeds of insurance to the reduction of the mortgage debt or otherwise, except in the event and to the extent either of a distribution of such proceeds to Unit Owners pursuant to Section 76-871 of the Act or of insurance proceeds in excess of the cost of repair or restoration being received by the Owner of the Unit encumbered by such mortgage; or (iii) to accelerate the mortgage debt or to have any other remedies by virtue of waste or alleged waste or other conditions occurring anywhere on the Property other than within the affected Unit, and the obligation secured shall be pre-payable, without penalty, upon the happening of any termination of the Condominium or determination not to restore or replace the affected Unit. Nothing contained in Section 12.1(a) hereinabove or elsewhere

in this Declaration shall give a Unit Owner, or any other party, priority over any rights of the mortgagee of a Unit pursuant to its mortgage in case of a distribution to such Unit Owner of insurance proceeds or condemnation awards for loss to or a taking of one or more Units and/or Common Elements.

(b) No Unit Owner or purchaser of a Unit shall deliver any mortgage or other lien instrument secured by a Unit, or any obligation to be secured thereby, unless it has first notified the Board of the name and address of the proposed mortgagee or lien holder, the amount of the debt proposed to be so secured, and has submitted to the Board a copy of the form of the proposed mortgage and note or other instrument of obligation. When a mortgage other than (i) a first mortgage or (ii) a junior mortgage to the Declarant or Seller of a Unit is delivered to the Board, the Board shall promptly notify the proposed mortgagee whether such mortgagee has been approved by the Board as a Qualified Lender.

12.2 Qualified Lenders.

(a) When a mortgage is delivered to a Qualified Lender or other lien holder, the Unit Owner shall simultaneously provide executed or conformed copies to the Board. Upon receipt of such copy of a mortgage or other lien, the Secretary of the Board may, at its option, instruct the insurer of the property to add the name of the Qualified Lender to the mortgagee loss payable provision of the hazard insurance policy covering the property and to provide such Qualified Lender with a Certificate of Insurance showing that the Qualified Lender's name has been so added.

(b) The Secretary shall maintain a register of Qualified Lender showing the names and addresses of the Qualified Lender, the amount secured by each Qualified Lender, and whether such amount secured is a first mortgage.

12.3 Rights of Qualified Lenders.

(a) Upon the specific written request of a holder of an Eligible Mortgage on a Unit or its servicer to the Board, the mortgagee shall be entitled to receive some or all of the following as designated in the request;

(i) Copies of budgets, notices of assessment, or any other notices or statements provided under this Declaration by the Board to the Owner of the Unit covered by the mortgage;

(ii) Any audited or unaudited financial statements of the Board which are prepared for the Board and distributed to the Unit Owners. The holder of any mortgage on a Unit shall be entitled to obtain an audited statement at its own expense, if one is not otherwise available;

(iii) Copies of notices of meetings of the Unit Owners and the right to be represented at any such meetings by a designated representative;

(iv) Notice of substantial damage to or destruction of any Unit (in excess of \$1,000) or any part of the Common Elements (in excess of \$10,000);

(v) Notice of the commencement of any condemnation or eminent domain proceedings with respect to any part of the Property;

(vi) Notice of any default of the Owner of the Unit which is subject to the mortgage, where such default is not cured by the Unit Owner within sixty (60) days;

(vii) Any lapse, cancellation or material modification of any insurance policy or fidelity bond maintained by the Association;

(viii) Notice of any decision by the Executive Board to terminate professional management and assume self-management of the Property;

(ix) Any condemnation or casualty loss that affects either a material part of the Condominium or the Unit securing the Qualified Lender's mortgage;

(x) Such other financial data as such Qualified Lender shall reasonably request; or

(xi) Any proposed action which would require the consent of a specified percentage of first mortgagees as set forth in Section 12.4, below.

(b) The request of a Qualified Lender or its servicer shall specify which of the above items it desires to receive and shall indicate the address to which any notices or documents shall be sent by the Board. The Board need not inquire into the validity of any request made hereunder by a Qualified Lender. The Board may refuse to honor any request where, after reasonable inquiry, it shall determine that the person making such request is not entitled to the material so requested and may establish reasonable rules to implement this Section 12.3(b).

(c) Failure to comply with the requirements set forth above shall in no way invalidate the otherwise proper actions of the Association and the Board.

(d) Any Qualified Lender shall have the right, exercisable upon written request to the Board, to examine the books and records of the Association at any reasonable time and with the payment of a reasonable fee established by the Board from time to time.

(e) Any reconstruction of the Condominium following damage by an insurable hazard or by condemnation shall be in accordance with the original Plan for the Condominium, unless deviation from such Plan is approved by the holders of at least fifty-one percent (51%) of Eligible Mortgages.

(f) Any election to terminate the Condominium Regime after substantial destruction or substantial taking of the Condominium shall be subject to approval by at least fifty-one percent (51%) of holders of Eligible Mortgages.

**ARTICLE XIII
MISCELLANEOUS PROVISIONS**

13.1 Effective Covenants. Each Purchaser and each grantee of Declarant, its successors and assigns, by the acceptance of a deed of conveyance, each Purchaser, accept the conveyed Property subject to all restrictions, conditions, covenants, reservations, options, liens and charges, and the jurisdiction, rights and powers granted or reserved by this Declaration or to which this Declaration is subject, and all rights, benefits and privileges of every character hereby granted, created, reserved or declared and all impositions and obligations hereby imposed shall be deemed and taken to be covenants running with the land and shall bind any Person having at any time any interest of estate in said Property, and shall inure to the benefit of such Condominium Unit Owner in like manner as though the provisions, terms and restrictions of this Declaration were received and stipulated at length in each and every deed of conveyance.

13.2 Waiver. No covenant, restriction, condition or provision of this Declaration or in the Bylaws shall be deemed to have been abrogated or waived by reason on any failure to enforce the same at any time, irrespective of the number of violations or breaches which may occur.

13.3 Savings Clause. The invalidity of any covenant, restriction, condition, limitation or any other provision of this Declaration herein contained, as the case may be, shall not render the remainder of the Declaration invalid, nor any other part therein contained.

13.4 Controlling Instrument. In the event of a conflict between the provisions of this Declaration and the Bylaws, this Declaration shall prevail except to the extent that this Declaration is inconsistent with the Act.

**ARTICLE XIV
AMENDMENT AND TERMINATION**

14.1 Amendments; Modifications and Terminations.

(a) The prior written approval of a Super-Majority Vote of the Unit Owners and at least sixty-seven percent (67%) of the votes of the holders of Eligible Mortgages of Units (based upon one (1) vote for each mortgage owned) shall be required to:

(i) Terminate the condominium status of the Property for any reasons, including substantial destruction or condemnation of the Property;

(ii) Abandon, encumber, sell or transfer any Common Elements (the granting of easements for public utilities or for other public purposes consistent

with the intended uses of the Common Elements shall not be deemed a transfer within the meaning of this subsection); or

(iii) The use of hazard insurance proceeds for losses to any Condominium Property (whether to Units or to Common Elements) for other than the repair, replacement or reconstruction of such Condominium Property.

(b) The prior written approval of a Super-Majority Vote of the Unit Owners and at least fifty-one (51%) percent of the holders of Eligible Mortgages of Units shall be required to make an amendment of a material nature to the Condominium Documents. A change in the provisions of any Condominium Document directly relating to any of the following shall for this purpose be considered material:

(i) A change in the manner or formula by which Common Elements or Limited Common Elements are allocated, or a change in the manner or formula by which the voting interests of a Unit are allocated;

(ii) Voting rights;

(iii) Increases in assessments that raise the previously assessed amount by more than twenty-five (25%) percent over the previous year's assessment, or the priority or the subordination of assessment liens;

(iv) Reduction in reserves for maintenance, repair and replacement of the Common Elements;

(v) Responsibility for maintenance and repairs;

(vi) Reallocation of interests in the Common Elements or Limited Common Elements or rights to their use;

(vii) Convertibility of Units into Common Elements or of Common Elements into Units;

(viii) Expansion or contraction of the Condominium or the addition, annexation or withdrawal of property to or from the Condominium;

(ix) Insurance or fidelity bond requirements;

(x) Change of restrictions on the leasing of any Units;

(xi) Imposition of any restrictions of a Unit Owner's right to sell or transfer his or her Unit;

(xii) A decision by the Association to establish self-management if any professional management had been required previously by a Qualified Lender;

(xiii) Restoration or repair of the Condominium (after a hazard damage or partial condemnation) in a manner other than that specified in the Condominium Documents;

(xiv) Actions to terminate the legal status of the Condominium after substantial destruction or condemnation occurs;

(xv) The method of assessments described in this Declaration;

(xvi) Provisions that expressly benefit holders, insurers or guarantors of Eligible Mortgages;

(xvii) Redefinition in any Unit boundaries;

(xviii) The imposition of any right of first refusal or similar restriction upon the rights of an Owner to convey a Unit; or

(xix) The establishment of self-management of the Association.

(c) Notwithstanding anything to the contrary in Section 14.1, written approval of holders of Eligible Mortgages of Units shall not be required for an amendment to this Declaration made pursuant to Article XV hereof.

14.2 Approval of Mortgagees. The approval rights granted to Qualified Lenders above shall be subject to the limitations imposed by Section 76-856 of the Act.

**ARTICLE XV
DECLARANT RIGHTS**

15.1 Development Activities. During the Period of Declarant Control, notwithstanding any provision herein to the contrary, the Declarant shall have the following rights and privileges, which are hereby reserved only to itself and to its successors and assigns and their respective agents:

(a) To create additional Units, Common Elements, Limited Common Elements within all or any part of the Condominium identified as the Additional Units, which Additional Units may be designated on the Plat/Plan as Additional Units or as "Reserved" or "Reserved for Future Development"; and to add property to the Condominium, provided, however, that the maximum number of Units which the Declarant reserves the right to create shall not exceed one hundred sixty (160) Units. Upon the addition of any Units to the Condominium, the Allocated Interests shall be reallocated among all units pursuant to the terms of this Declaration and the formula set forth herein.

(b) To exercise any Special Declarant Rights provided for under the Act.

(c) To erect and maintain on the Common Elements, advertising signs, sales flags or other sales devices and banners for the purpose of aiding the sale of Units in the Condominium, and to maintain sales and business offices in at least one Unit or in any Common Element or building in this Condominium to facilitate the completion of construction of the Improvements comprising this Condominium, apartments and homes now or hereafter constructed within said development and sale of the Units therein contained.

(d) To erect or maintain on the Common Areas any sales office facilities, either of a modular or permanent construction, in the sole discretion of the Declarant, its successors, assigns or their agents, that will aid in the sale, marketing or advertising of the Condominium Units.

(e) To maintain on the Common Areas tractors, portable toilets, and other items necessary for the construction of the Improvements.

The consent of Unit Owners and mortgage holders within the Condominium shall not be required for the exercise of any of the foregoing Development Rights, and the Declarant may proceed with the exercise of such Development Rights at its sole option and its sole discretion. The option reserved to (i) relocate the boundaries of any Unit or Units, and (ii) further subdivide any one or more of the Units into additional Units, Common Elements or both, shall be exercisable by the Declarant, its successors and assigns, who shall have the unilateral right to reallocate percentages of undivided interests in the Common Elements, liability for payment of Common Expenses, allocation of Limited Common Elements, and allocation of votes in the Association, as to be done in accordance with this Declaration and the Act. The Declarant shall exercise this option by its adoption, execution or recordation of an Amendment to this Declaration by recording such certificates and plans as required by the Act. Such amendment shall be adopted by the Declarant pursuant to the terms hereof without the consent of any Unit Owners. From time to time, as the Declarant shall file permitted amendments to this Declaration, each then Owner and each Person or entity thereafter becoming an Owner and its successors in title shall, upon the reallocation of such Common Elements or Limited Common Elements automatically be vested with his or her appropriate Allocated Interest and be vested with his or her appropriate undivided percentage interest in such Common Elements and Limited Common Elements.

15.2 Permanent Access and Utility Easement. The Declarant reserves unto itself, its successors and assigns, a permanent easement for ingress, egress and utility purposes to any adjacent properties now or hereafter owned by Declarant, its successors and assigns as shown on the Plat and Plans.

15.3 Special Amendment. In addition to any other method of amending this Declaration provided for elsewhere herein, the Declarant reserves the right and power to record a special amendment ("Special Amendment") to this Declaration at any time and from time to time which amends this Declaration: (i) to comply with requirements of the Federal National Mortgage Association, the Government National Mortgage Association, the Federal Home Loan Mortgage Corporation, the Department of Housing and Urban Development, the Federal Housing Association, the Veteran's Administration, or any other governmental agency or any

other public, quasi-public or private entity which performs (or may in the future perform) functions similar to those currently performed by such entities, (ii) to induce any of such agencies or entities to make, purchase, sell, insure, or guarantee first mortgages covering Units, (iii) to bring this Declaration into compliance with the Act, or (iv) to correct clerical or typographical errors in this Declaration or any exhibit hereto or any supplement or amendment thereto. In furtherance of the foregoing, a power coupled with an interest is hereby reserved and granted to the Declarant to make or consent to a Special Amendment on behalf of each Owner and mortgage holder. Each deed, mortgage, trust deed, other evidence of obligation, or other instrument affecting a Unit and the acceptance thereof shall be deemed to be a grant and acknowledgment of, and a consent to the reservation of, the power to the Declarant to make, execute and record Special Amendments. The reserved rights of the Declarant under this Article XV shall terminate three (3) years from the date of recording of the Declaration.

15.4 Phasing and Expansion. The Declarant may construct or cause to be constructed the Improvements in the Condominium, including the construction of Units, in multiple phases. Such phases are set forth in the Plans. The construction of Units in additional phases, and the allocation of voting rights and rights to the Common Elements associated with such Units to be constructed in later phases are contemplated, allowed and governed by this Declaration. Only the initial phase of construction is required by this Declaration. Additional phases may be constructed in any order, regardless of the numerical designations of such phases.

IN WITNESS WHEREOF, Triton Homes, L.C., an Iowa limited liability company, doing business in Nebraska as Triton Homes, LLC, has caused these presents to be signed by its authorized member, the day and year first above written.

DECLARANT:

TRITON HOMES, L.C., an Iowa limited liability company, doing business in Nebraska as TRITON HOMES, LLC

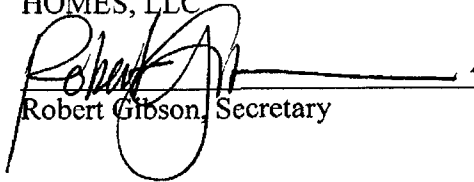
Robert Gibson, Secretary

STATE OF NEBRASKA)
) ss.
COUNTY OF DOUGLAS)

The foregoing instrument was acknowledge before me this 7th day of June, 2006 by Robert Gibson, the Secretary of Triton Homes, L.C., an Iowa limited liability company, doing business in Nebraska as Triton Homes, LLC, on behalf of the company.

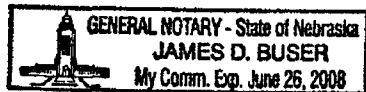

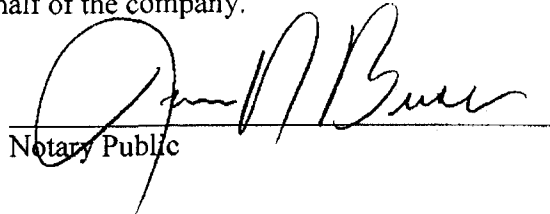

Notary Public

**EXHIBIT A
LEGAL DESCRIPTION**

Lot 1, Stone Creek Village, a Subdivision, as surveyed, platted and recorded in Douglas County, Nebraska.

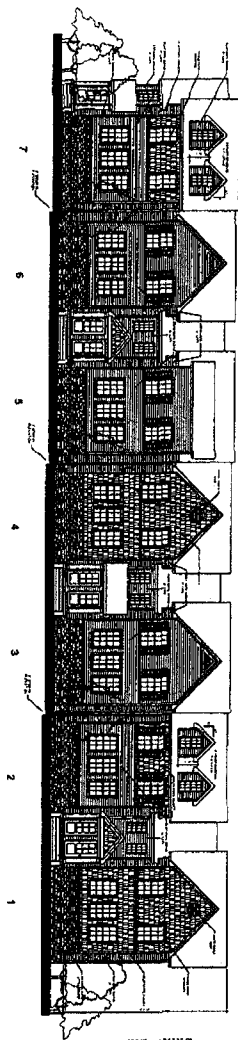
**EXHIBIT B
PLANS**



4 Front Elevation
SCALE: 3/32"=1'-0"

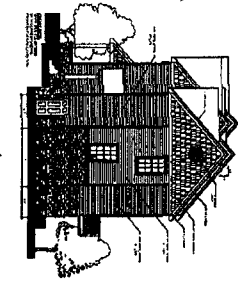

3 Right Elevation
SCALE: 3/32"=1'-0"

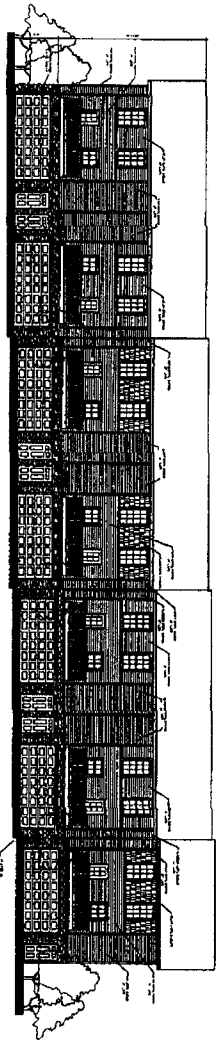

2 Rear Elevation
SCALE: 3/32"=1'-0"

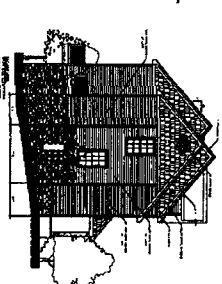

1 Left Elevation
SCALE: 3/32"=1'-0"

A-1	<p>JCorp, Inc. consulting engineers</p> <p>70 and 160 Monday to Friday Phone (416) 881-4001 Fax (416) 881-4002</p> <p>ARCHITECTURAL • STRUCTURAL • CONSTRUCTION • ENGINEERING</p>	<p>TRITON HOMES. 1800 SE Delaware Ave. Suite 100 Amherst, Iowa 50005 www.triton-homes.com 916.966.3300 Fax: 916.966.0889</p>
	<p>PROJECT Stone Creek Village 7-Unit Townhome, Block AA Cambridge Plan Building Numbers: 1-7 Omaha, NE</p>	

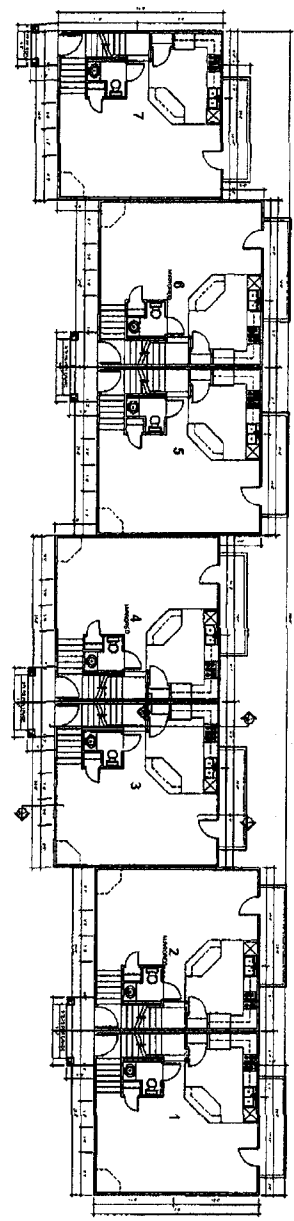

2 Main Level Plan
SCALE: 1/8"=1'-0"

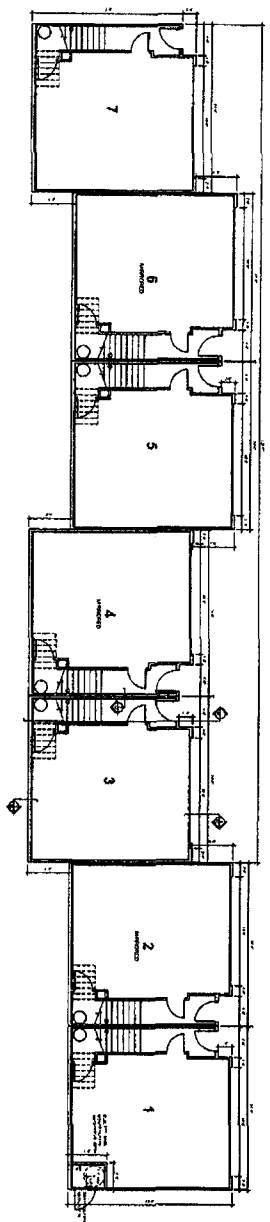

1 Garage Level Plan
SCALE: 1/8"=1'-0"

A-2	PROJECT: Stone Creek Village 7-Unit Townhome, Bldg AA Cambridge Plan Building Numbers: 1-7 Omaha, NE	JCorp. Inc. consulting engineers P.O. Box 988 Omaha, NE 68104 Phone: (402) 647-6827 Fax: (402) 647-6821 www.jcorp.com	TRITON HOMES. 1800 SE Delaware Ave. Suite 105 Omaha, NE 68102 402-342-8888 PH: 313-984-3300 FAX: 313-973-0500
	REVISIONS: NO. DATE BY 1 4/21/08 2 4/21/08 3 4/21/08 4 4/21/08 5 4/21/08 6 4/21/08 7 4/21/08 8 4/21/08 9 4/21/08 10 4/21/08 11 4/21/08 12 4/21/08 13 4/21/08 14 4/21/08 15 4/21/08 16 4/21/08 17 4/21/08 18 4/21/08 19 4/21/08 20 4/21/08 21 4/21/08 22 4/21/08 23 4/21/08 24 4/21/08 25 4/21/08 26 4/21/08 27 4/21/08 28 4/21/08 29 4/21/08 30 4/21/08 31 4/21/08 32 4/21/08 33 4/21/08 34 4/21/08 35 4/21/08 36 4/21/08 37 4/21/08 38 4/21/08 39 4/21/08 40 4/21/08 41 4/21/08 42 4/21/08 43 4/21/08 44 4/21/08 45 4/21/08 46 4/21/08 47 4/21/08 48 4/21/08 49 4/21/08 50 4/21/08 51 4/21/08 52 4/21/08 53 4/21/08 54 4/21/08 55 4/21/08 56 4/21/08 57 4/21/08 58 4/21/08 59 4/21/08 60 4/21/08 61 4/21/08 62 4/21/08 63 4/21/08 64 4/21/08 65 4/21/08 66 4/21/08 67 4/21/08 68 4/21/08 69 4/21/08 70 4/21/08 71 4/21/08 72 4/21/08 73 4/21/08 74 4/21/08 75 4/21/08 76 4/21/08 77 4/21/08 78 4/21/08 79 4/21/08 80 4/21/08 81 4/21/08 82 4/21/08 83 4/21/08 84 4/21/08 85 4/21/08 86 4/21/08 87 4/21/08 88 4/21/08 89 4/21/08 90 4/21/08 91 4/21/08 92 4/21/08 93 4/21/08 94 4/21/08 95 4/21/08 96 4/21/08 97 4/21/08 98 4/21/08 99 4/21/08 100 4/21/08		

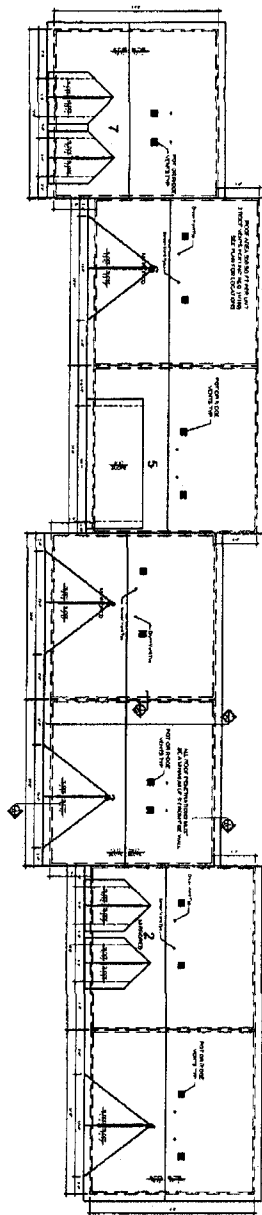

2 Roof Plan
SCALE 1/8"=1'-0"

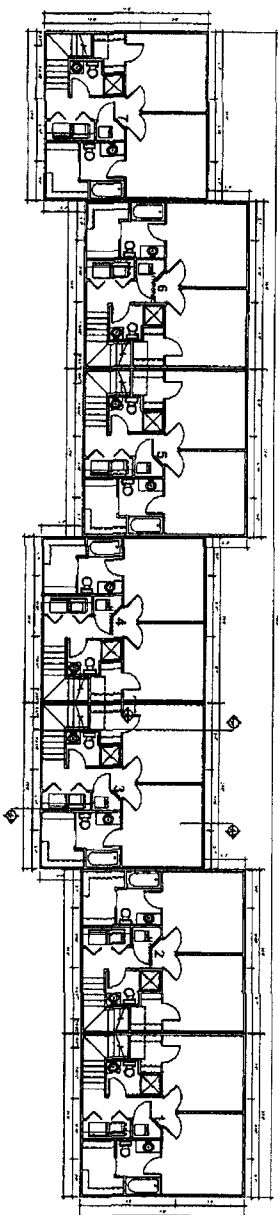

1 Upper Level Plan
SCALE 1/8"=1'-0"

A-3

PROJECT:	Stone Creek Village
DESCRIPTION:	7-Unit Townhome, Bldg AA
LOCATION:	Cambridge Plan
DATE:	Building Numbers: 1-7
SCALE:	Omaha, NE
DATE:	
BY:	
CHECKED:	
DATE:	
PROJECT NO.:	
DATE:	8/21/08
SCALE:	
BY:	
CHECKED:	
DATE:	
PROJECT NO.:	
DATE:	
BY:	
CHECKED:	
DATE:	

JCorp Inc.
consulting engineers
P.O. Box 198, Piquette, MI 48864
Phone: (517) 467-6661 Fax: (517) 467-6661

TRITON HOMES
1807 SE Delaware Ave. #402 185
Auburn, Iowa 52001
www.tritonhomes.com
ph: 515.964.3360 fax: 515.965.0560

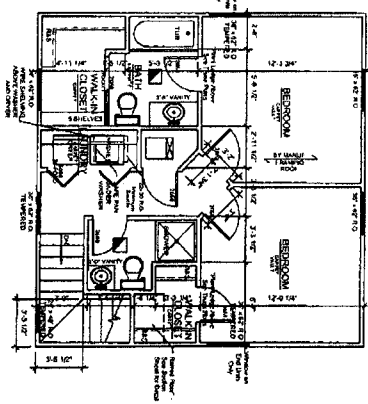

6 Upper Level Plan, Mirrored
SCALE: 1/4" = 1'-0"

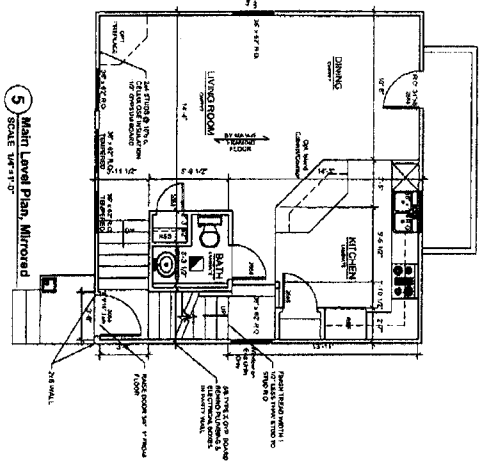

5 Main Level Plan, Mirrored
SCALE: 1/4" = 1'-0"

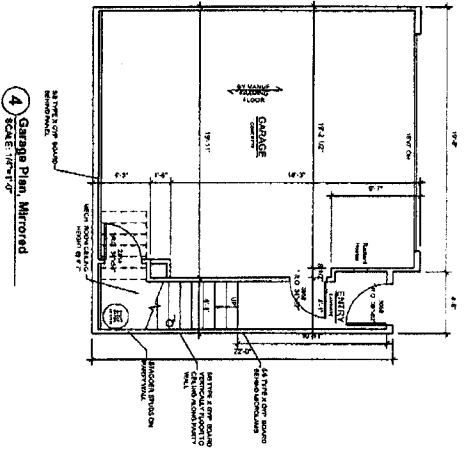

4 Garage Plan, Mirrored
SCALE: 1/4" = 1'-0"

Cambridge Plan

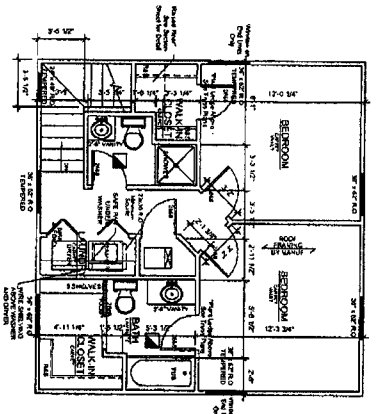

3 Upper Level Plan
SCALE: 1/4" = 1'-0"

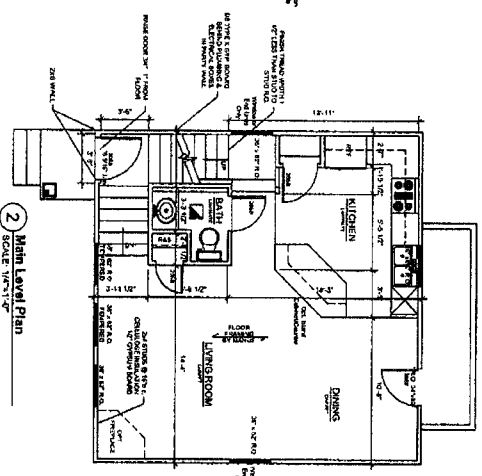

2 Main Level Plan
SCALE: 1/4" = 1'-0"

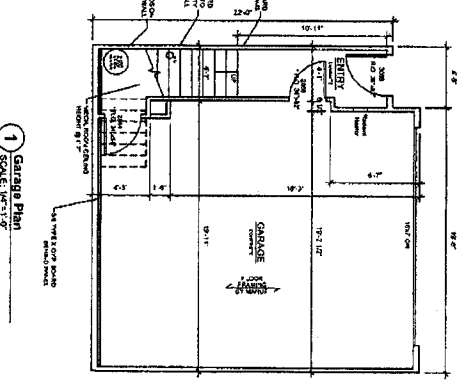

1 Garage Plan
SCALE: 1/4" = 1'-0"

A-4

PROJECT:	Stone Creek Village
	7-Unit Townhome, Bldg AA
	Cambridge Plan
	Building Numbers: 1-7
	Omaha, NE
DATE:	11/21/08
PROJECT NO.:	41217/08
OWNER:	
DESIGNER:	JC Corp. Inc.
SCALE:	1/4" = 1'-0"
DATE:	11/21/08
PROJECT NO.:	41217/08
OWNER:	
DESIGNER:	JC Corp. Inc.
SCALE:	1/4" = 1'-0"
DATE:	11/21/08

JCorp. Inc.
consulting engineers
P.O. Box 110 • Omaha, NE 68104
Phone (416) 861-4444 • Fax (416) 867-4444
www.jc-engineers.com

TRITON HOMES.
1005 SE Delaware Ave. • Suite 110
Omaha, Iowa 68105
www.triton-homes.com
PH: 515.364.1500 FAX: 515.363.0500

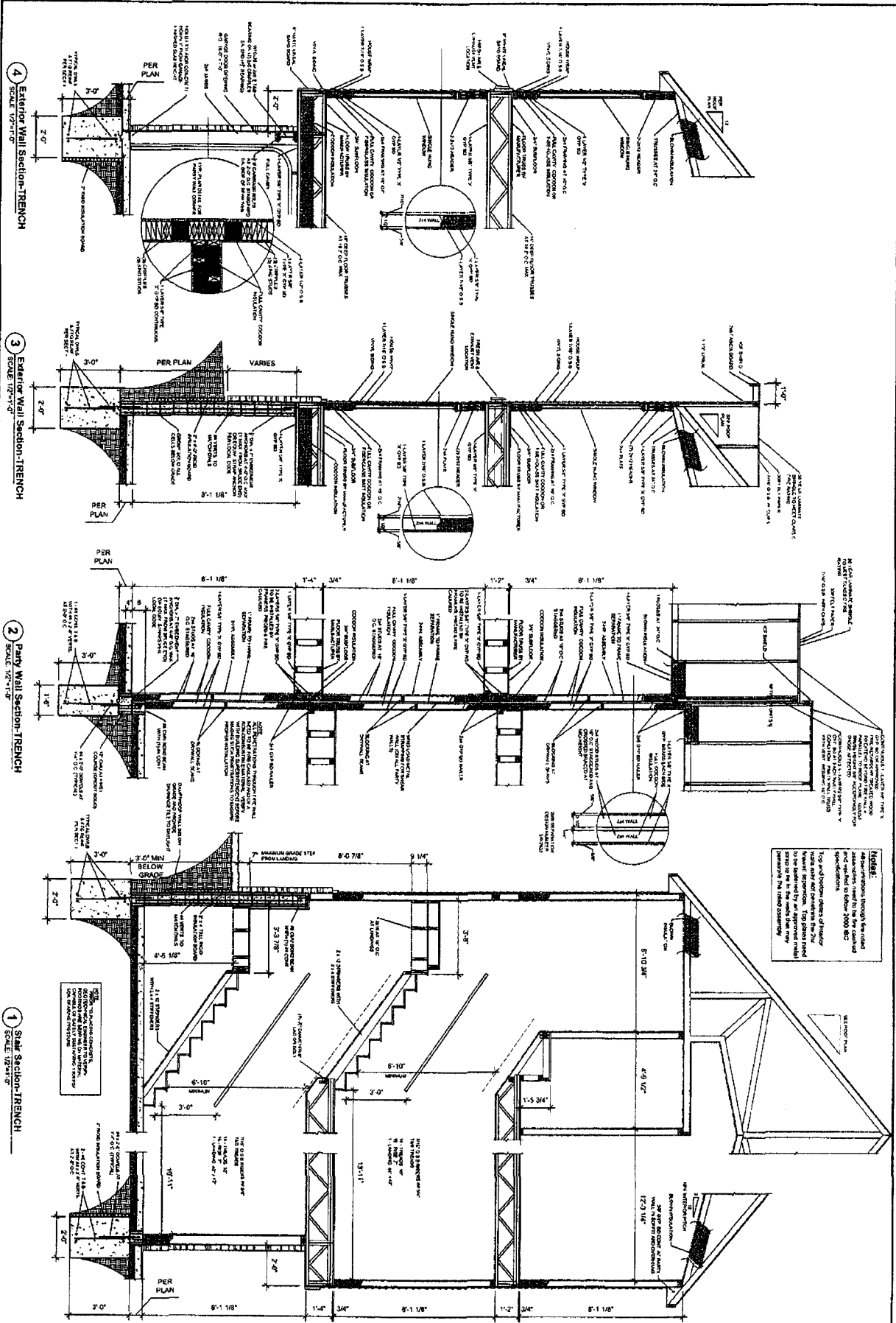

4 Exterior Wall Section-TRENCH
SCALE: 1/2"=1'-0"

3 Exterior Wall Section-TRENCH
SCALE: 1/2"=1'-0"

2 Party Wall Section-TRENCH
SCALE: 1/2"=1'-0"

1 Stair Section-TRENCH
SCALE: 1/2"=1'-0"

NOTES:
 1. All dimensions shown through the field of a wall are to the face of the masonry unless otherwise indicated.
 2. All dimensions shown through the field of a wall are to the face of the masonry unless otherwise indicated.
 3. All dimensions shown through the field of a wall are to the face of the masonry unless otherwise indicated.
 4. All dimensions shown through the field of a wall are to the face of the masonry unless otherwise indicated.
 5. All dimensions shown through the field of a wall are to the face of the masonry unless otherwise indicated.
 6. All dimensions shown through the field of a wall are to the face of the masonry unless otherwise indicated.
 7. All dimensions shown through the field of a wall are to the face of the masonry unless otherwise indicated.
 8. All dimensions shown through the field of a wall are to the face of the masonry unless otherwise indicated.
 9. All dimensions shown through the field of a wall are to the face of the masonry unless otherwise indicated.
 10. All dimensions shown through the field of a wall are to the face of the masonry unless otherwise indicated.

A-5

PROJECT: Stone Creek Village
 7-Unit Townhome, Block AA
 Cambridge Plan
 Building Numbers: 1-7
 Omaha, NE

DATE: 03/09/08
 DRAWN BY: [Name]
 CHECKED BY: [Name]

CERTIFICATION:
 I certify that the design herein prepared by [Name] is a true and correct representation of the work done by me or under my direct supervision and that I am a duly registered engineer under the laws of the State of Iowa.

DATE: 03/09/08

JCorp Inc.
 consulting engineers

1000 S. 10th Street, Suite 100
 Des Moines, IA 50319
 Phone: 515.281.4400 Fax: 515.281.4401

TRITON HOMES.
 1800 S. 10th Street, Suite 100
 Des Moines, IA 50319
 Phone: 515.281.4400 Fax: 515.281.4401

PROJECT INFORMATION - Stone Creek Village
 PART: P
 TOTAL VA
 OVERLAP

MECHANICAL EQUIPMENT AND SUPPLY	13,000	4,100	0	0	0	0	0	0	0
HEATING ONLY	13,000	4,100	0	0	0	0	0	0	0
HEATING AND COOLING ONLY	13,000	4,100	0	0	0	0	0	0	0
COOLING ONLY	0	0	0	0	0	0	0	0	0
LOAD TOTAL	13,000	4,100	0	0	0	0	0	0	0
LOAD DENSITY	141	44	0	0	0	0	0	0	0

TABLE NO. 2
 TOTAL VA
 OVERLAP

NO.	DESCRIPTION	VA	UNIT	AMP	POLES	LOAD TYPE	PHASE	REMARKS
1	RESTROOM REC	13000	12	20	2	RESISTIVE	3	
2	KITCHEN REC	15000	12	20	2	RESISTIVE	3	
3	HALLWAY REC	10000	12	20	2	RESISTIVE	3	
4	LAUNDRY REC	10000	12	20	2	RESISTIVE	3	
5	WATERHEATER	0	480	30	2	RESISTIVE	3	
6	GENERAL USE REC	4100	12	20	2	RESISTIVE	3	
7	GENERAL USE REC	4100	12	20	2	RESISTIVE	3	
8	GENERAL USE REC	4100	12	20	2	RESISTIVE	3	
9	GENERAL USE REC	4100	12	20	2	RESISTIVE	3	
10	GENERAL USE REC	4100	12	20	2	RESISTIVE	3	
11	GENERAL USE REC	4100	12	20	2	RESISTIVE	3	
12	GENERAL USE REC	4100	12	20	2	RESISTIVE	3	
13	GENERAL USE REC	4100	12	20	2	RESISTIVE	3	
14	GENERAL USE REC	4100	12	20	2	RESISTIVE	3	
15	GENERAL USE REC	4100	12	20	2	RESISTIVE	3	
16	GENERAL USE REC	4100	12	20	2	RESISTIVE	3	
17	GENERAL USE REC	4100	12	20	2	RESISTIVE	3	
18	GENERAL USE REC	4100	12	20	2	RESISTIVE	3	
19	GENERAL USE REC	4100	12	20	2	RESISTIVE	3	
20	GENERAL USE REC	4100	12	20	2	RESISTIVE	3	
21	GENERAL USE REC	4100	12	20	2	RESISTIVE	3	
22	GENERAL USE REC	4100	12	20	2	RESISTIVE	3	
23	GENERAL USE REC	4100	12	20	2	RESISTIVE	3	
24	GENERAL USE REC	4100	12	20	2	RESISTIVE	3	
25	GENERAL USE REC	4100	12	20	2	RESISTIVE	3	
26	GENERAL USE REC	4100	12	20	2	RESISTIVE	3	
27	GENERAL USE REC	4100	12	20	2	RESISTIVE	3	
28	GENERAL USE REC	4100	12	20	2	RESISTIVE	3	
29	GENERAL USE REC	4100	12	20	2	RESISTIVE	3	
30	GENERAL USE REC	4100	12	20	2	RESISTIVE	3	

ELECTRICAL CONTRACTOR TO ENSURE THAT ALL WORK IS CODE COMPLIANT.

- GENERAL NOTES**
1. SHOW PANELS AND EQUIPMENT LOCATED PER CODE AND FIELD MARK.
 2. LISTING CODES, APPROVED BY THE AHJ.
 3. CHANGE (1) PROVISION NUMBER PER BAY.
 4. CHANGE (2) PROVISION NUMBER PER BAY.
 5. CHANGE (3) PROVISION NUMBER PER BAY.
 6. CHANGE (4) PROVISION NUMBER PER BAY.
 7. CHANGE (5) PROVISION NUMBER PER BAY.
 8. CHANGE (6) PROVISION NUMBER PER BAY.
 9. CHANGE (7) PROVISION NUMBER PER BAY.
 10. CHANGE (8) PROVISION NUMBER PER BAY.
 11. CHANGE (9) PROVISION NUMBER PER BAY.
 12. CHANGE (10) PROVISION NUMBER PER BAY.
 13. CHANGE (11) PROVISION NUMBER PER BAY.
 14. CHANGE (12) PROVISION NUMBER PER BAY.
 15. CHANGE (13) PROVISION NUMBER PER BAY.
 16. CHANGE (14) PROVISION NUMBER PER BAY.
 17. CHANGE (15) PROVISION NUMBER PER BAY.
 18. CHANGE (16) PROVISION NUMBER PER BAY.
 19. CHANGE (17) PROVISION NUMBER PER BAY.
 20. CHANGE (18) PROVISION NUMBER PER BAY.
 21. CHANGE (19) PROVISION NUMBER PER BAY.
 22. CHANGE (20) PROVISION NUMBER PER BAY.
 23. CHANGE (21) PROVISION NUMBER PER BAY.
 24. CHANGE (22) PROVISION NUMBER PER BAY.
 25. CHANGE (23) PROVISION NUMBER PER BAY.
 26. CHANGE (24) PROVISION NUMBER PER BAY.
 27. CHANGE (25) PROVISION NUMBER PER BAY.
 28. CHANGE (26) PROVISION NUMBER PER BAY.
 29. CHANGE (27) PROVISION NUMBER PER BAY.
 30. CHANGE (28) PROVISION NUMBER PER BAY.
 31. CHANGE (29) PROVISION NUMBER PER BAY.
 32. CHANGE (30) PROVISION NUMBER PER BAY.
 33. CHANGE (31) PROVISION NUMBER PER BAY.
 34. CHANGE (32) PROVISION NUMBER PER BAY.
 35. CHANGE (33) PROVISION NUMBER PER BAY.
 36. CHANGE (34) PROVISION NUMBER PER BAY.
 37. CHANGE (35) PROVISION NUMBER PER BAY.
 38. CHANGE (36) PROVISION NUMBER PER BAY.
 39. CHANGE (37) PROVISION NUMBER PER BAY.
 40. CHANGE (38) PROVISION NUMBER PER BAY.
 41. CHANGE (39) PROVISION NUMBER PER BAY.
 42. CHANGE (40) PROVISION NUMBER PER BAY.
 43. CHANGE (41) PROVISION NUMBER PER BAY.
 44. CHANGE (42) PROVISION NUMBER PER BAY.
 45. CHANGE (43) PROVISION NUMBER PER BAY.
 46. CHANGE (44) PROVISION NUMBER PER BAY.
 47. CHANGE (45) PROVISION NUMBER PER BAY.
 48. CHANGE (46) PROVISION NUMBER PER BAY.
 49. CHANGE (47) PROVISION NUMBER PER BAY.
 50. CHANGE (48) PROVISION NUMBER PER BAY.
 51. CHANGE (49) PROVISION NUMBER PER BAY.
 52. CHANGE (50) PROVISION NUMBER PER BAY.
 53. CHANGE (51) PROVISION NUMBER PER BAY.
 54. CHANGE (52) PROVISION NUMBER PER BAY.
 55. CHANGE (53) PROVISION NUMBER PER BAY.
 56. CHANGE (54) PROVISION NUMBER PER BAY.
 57. CHANGE (55) PROVISION NUMBER PER BAY.
 58. CHANGE (56) PROVISION NUMBER PER BAY.
 59. CHANGE (57) PROVISION NUMBER PER BAY.
 60. CHANGE (58) PROVISION NUMBER PER BAY.
 61. CHANGE (59) PROVISION NUMBER PER BAY.
 62. CHANGE (60) PROVISION NUMBER PER BAY.
 63. CHANGE (61) PROVISION NUMBER PER BAY.
 64. CHANGE (62) PROVISION NUMBER PER BAY.
 65. CHANGE (63) PROVISION NUMBER PER BAY.
 66. CHANGE (64) PROVISION NUMBER PER BAY.
 67. CHANGE (65) PROVISION NUMBER PER BAY.
 68. CHANGE (66) PROVISION NUMBER PER BAY.
 69. CHANGE (67) PROVISION NUMBER PER BAY.
 70. CHANGE (68) PROVISION NUMBER PER BAY.
 71. CHANGE (69) PROVISION NUMBER PER BAY.
 72. CHANGE (70) PROVISION NUMBER PER BAY.
 73. CHANGE (71) PROVISION NUMBER PER BAY.
 74. CHANGE (72) PROVISION NUMBER PER BAY.
 75. CHANGE (73) PROVISION NUMBER PER BAY.
 76. CHANGE (74) PROVISION NUMBER PER BAY.
 77. CHANGE (75) PROVISION NUMBER PER BAY.
 78. CHANGE (76) PROVISION NUMBER PER BAY.
 79. CHANGE (77) PROVISION NUMBER PER BAY.
 80. CHANGE (78) PROVISION NUMBER PER BAY.
 81. CHANGE (79) PROVISION NUMBER PER BAY.
 82. CHANGE (80) PROVISION NUMBER PER BAY.
 83. CHANGE (81) PROVISION NUMBER PER BAY.
 84. CHANGE (82) PROVISION NUMBER PER BAY.
 85. CHANGE (83) PROVISION NUMBER PER BAY.
 86. CHANGE (84) PROVISION NUMBER PER BAY.
 87. CHANGE (85) PROVISION NUMBER PER BAY.
 88. CHANGE (86) PROVISION NUMBER PER BAY.
 89. CHANGE (87) PROVISION NUMBER PER BAY.
 90. CHANGE (88) PROVISION NUMBER PER BAY.
 91. CHANGE (89) PROVISION NUMBER PER BAY.
 92. CHANGE (90) PROVISION NUMBER PER BAY.
 93. CHANGE (91) PROVISION NUMBER PER BAY.
 94. CHANGE (92) PROVISION NUMBER PER BAY.
 95. CHANGE (93) PROVISION NUMBER PER BAY.
 96. CHANGE (94) PROVISION NUMBER PER BAY.
 97. CHANGE (95) PROVISION NUMBER PER BAY.
 98. CHANGE (96) PROVISION NUMBER PER BAY.
 99. CHANGE (97) PROVISION NUMBER PER BAY.
 100. CHANGE (98) PROVISION NUMBER PER BAY.
 101. CHANGE (99) PROVISION NUMBER PER BAY.
 102. CHANGE (100) PROVISION NUMBER PER BAY.

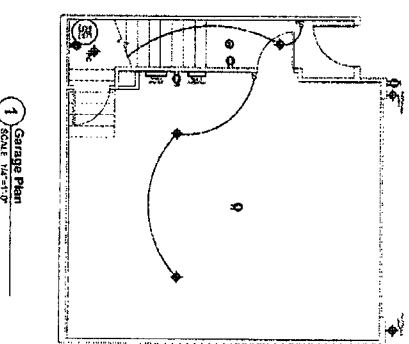
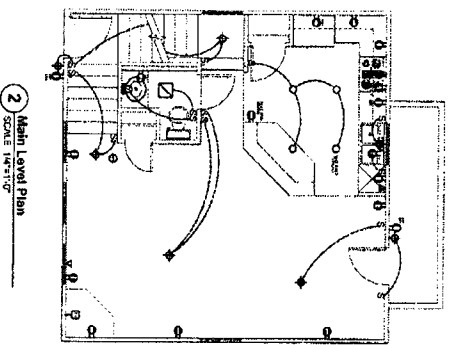
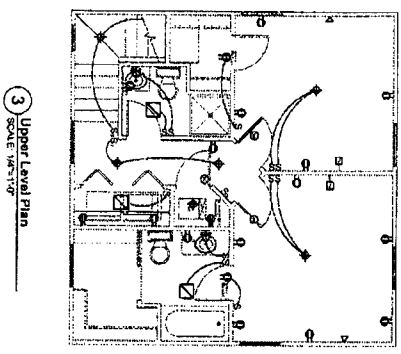

Cambridge Plan



I hereby certify that the engineering described on this drawing was prepared by me or under my direct supervision and that I am a duly Licensed Professional Engineer under the laws of the State of Virginia. This drawing is issued under my License No. 10000.

Robert K. Brewer
 License No. 10000
 State of Virginia

<p>Brewer Engineering Consultants, P.C. 2001 W. EXPANDED ST. #1 - ANNAPOLIS, MD 21403 410-293-8700 - FAX 410-293-8701 - 800-222-8500</p>	<p>PROJECT Stone Creek Village 7-Unit Townhome, Bldg AA Cambridge Plan Building Numbers: 1-7 Omaha, NE</p>
	<p>DATE: 04/17/08 DRAWN BY: [Name] CHECKED BY: [Name] SCALE: 1/2"=1'-0"</p>

E-1

Mechanical Symbols:

	4410 Supply Air
	Return Air GHI
	Thermostat
	Bath Vent
	Dryer Vent
	Furnace
	Air Conditioner

MECHANICAL CONTRACTOR TO ENSURE THAT ALL WORK IS CODE COMPLIANT.

Mechanical Notes:
 Supply ducts in 6" & 4" insulated R4 & R6
 14" x 6" supply duct
 Return ducts in 6" R4 & ducting 14" x 14"
 ducts to be done in 4" vinyl

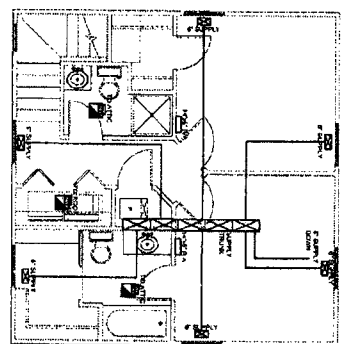

3 Upper Level Plan
SCALE: 1/4"=1'-0"

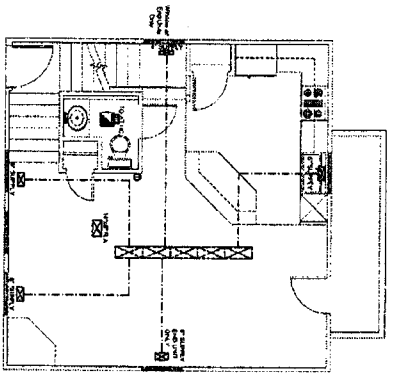

2 Main Level Plan
SCALE: 1/4"=1'-0"

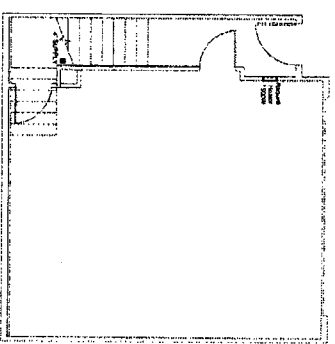

1 Garage Plan
SCALE: 1/4"=1'-0"

Cambridge Plan



I hereby certify that this engineering document was prepared by me or under my direct supervision and that I am a duly Licensed Professional Engineer under the laws of the State of Nebraska.
 Steven L. Brumder, License No. 0000000000, State of Nebraska
 The seal is required by the statute.

<p>M-1</p>	<p>PROJECT: Stone Creek Village 7-Unit Townhome, Bldg AA Cambridge Plan Building Numbers: 1-7 Omaha, NE</p>	<p>REV: 0112</p> <p>BREWER ENGINEERING CONSULTANTS, P.L.C.</p> <p>2701 BE CONVENT ROAD, STE. 111, ANCHORAGE, ALASKA 99501 907-563-6760 • FAX 907-563-6768 • WWW.BREWER-ENG.COM</p>
	<p>DATE: 01/11/06</p> <p>SCALE: 1/4"=1'-0"</p> <p>PROJECT NO. 06-001</p> <p>DATE: 01/11/06</p> <p>SCALE: 1/4"=1'-0"</p> <p>PROJECT NO. 06-001</p>	

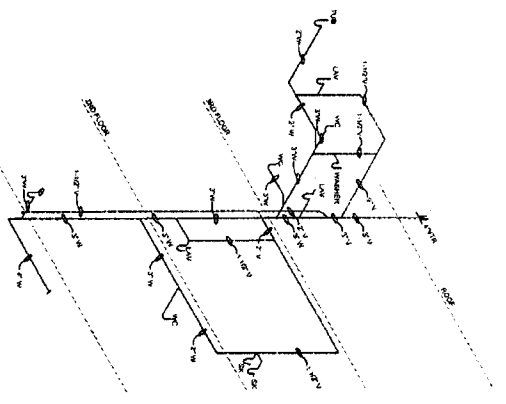

4 Plumbing Isometric
SCALE: NO SCALE

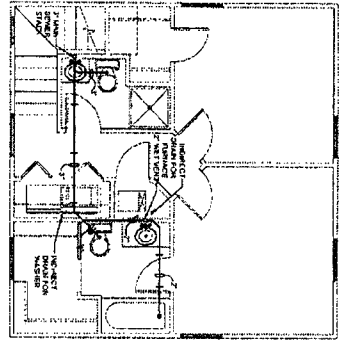

3 Upper Level Plan
SCALE: 1/8"=1'-0"

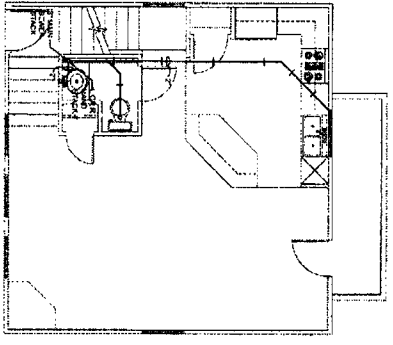

2 Main Level Plan
SCALE: 1/8"=1'-0"

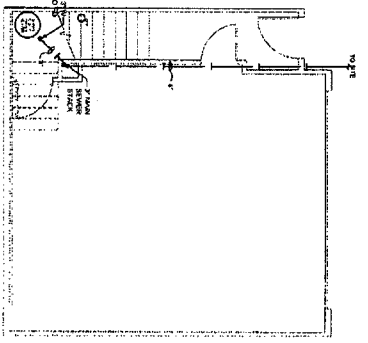

1 Garage Plan
SCALE: 1/8"=1'-0"

PLUMBING CONTRACTOR TO ENSURE THAT ALL WORK IS CODE COMPLIANT.

- PLUMBING NOTES**
1. PROVIDE VALVE AFTER HIS DIVISION REQUIREMENTS.
 2. ALL PLUMBING FIXTURES SHALL BE 1/2" APPROX FROM OTHER SUBMITTALS UNLESS NOTED OTHERWISE.
 3. MAKE AND LOW POINT SHALL BE INDICATED ON PNC.
 4. WATER SHUT-OFF SHALL BE LOCATED AT BUILDING EXTERIOR.
 5. SHUT-OFF SHALL BE APPROXIMATELY 3' FROM MAIN BATH.
 6. PROVIDE 1" HOSELESS IN UTILITY ROOM.
 7. MAIN LEVEL BATH:
 8. MAIN LEVEL BATH:
 9. MAIN LEVEL BATH:
 10. MAIN LEVEL BATH:
 11. MAIN LEVEL BATH:
 12. MAIN LEVEL BATH:
 13. MAIN LEVEL BATH:
 14. MAIN LEVEL BATH:
 15. MAIN LEVEL BATH:
 16. MAIN LEVEL BATH:
 17. MAIN LEVEL BATH:
 18. MAIN LEVEL BATH:
 19. MAIN LEVEL BATH:
 20. MAIN LEVEL BATH:
 21. MAIN LEVEL BATH:
 22. MAIN LEVEL BATH:
 23. MAIN LEVEL BATH:
 24. MAIN LEVEL BATH:
 25. MAIN LEVEL BATH:
 26. MAIN LEVEL BATH:
 27. MAIN LEVEL BATH:
 28. MAIN LEVEL BATH:
 29. MAIN LEVEL BATH:
 30. MAIN LEVEL BATH:
 31. MAIN LEVEL BATH:
 32. MAIN LEVEL BATH:
 33. MAIN LEVEL BATH:
 34. MAIN LEVEL BATH:
 35. MAIN LEVEL BATH:
 36. MAIN LEVEL BATH:
 37. MAIN LEVEL BATH:
 38. MAIN LEVEL BATH:
 39. MAIN LEVEL BATH:
 40. MAIN LEVEL BATH:
 41. MAIN LEVEL BATH:
 42. MAIN LEVEL BATH:
 43. MAIN LEVEL BATH:
 44. MAIN LEVEL BATH:
 45. MAIN LEVEL BATH:
 46. MAIN LEVEL BATH:
 47. MAIN LEVEL BATH:
 48. MAIN LEVEL BATH:
 49. MAIN LEVEL BATH:
 50. MAIN LEVEL BATH:
 51. MAIN LEVEL BATH:
 52. MAIN LEVEL BATH:
 53. MAIN LEVEL BATH:
 54. MAIN LEVEL BATH:
 55. MAIN LEVEL BATH:
 56. MAIN LEVEL BATH:
 57. MAIN LEVEL BATH:
 58. MAIN LEVEL BATH:
 59. MAIN LEVEL BATH:
 60. MAIN LEVEL BATH:
 61. MAIN LEVEL BATH:
 62. MAIN LEVEL BATH:
 63. MAIN LEVEL BATH:
 64. MAIN LEVEL BATH:
 65. MAIN LEVEL BATH:
 66. MAIN LEVEL BATH:
 67. MAIN LEVEL BATH:
 68. MAIN LEVEL BATH:
 69. MAIN LEVEL BATH:
 70. MAIN LEVEL BATH:
 71. MAIN LEVEL BATH:
 72. MAIN LEVEL BATH:
 73. MAIN LEVEL BATH:
 74. MAIN LEVEL BATH:
 75. MAIN LEVEL BATH:
 76. MAIN LEVEL BATH:
 77. MAIN LEVEL BATH:
 78. MAIN LEVEL BATH:
 79. MAIN LEVEL BATH:
 80. MAIN LEVEL BATH:
 81. MAIN LEVEL BATH:
 82. MAIN LEVEL BATH:
 83. MAIN LEVEL BATH:
 84. MAIN LEVEL BATH:
 85. MAIN LEVEL BATH:
 86. MAIN LEVEL BATH:
 87. MAIN LEVEL BATH:
 88. MAIN LEVEL BATH:
 89. MAIN LEVEL BATH:
 90. MAIN LEVEL BATH:
 91. MAIN LEVEL BATH:
 92. MAIN LEVEL BATH:
 93. MAIN LEVEL BATH:
 94. MAIN LEVEL BATH:
 95. MAIN LEVEL BATH:
 96. MAIN LEVEL BATH:
 97. MAIN LEVEL BATH:
 98. MAIN LEVEL BATH:
 99. MAIN LEVEL BATH:
 100. MAIN LEVEL BATH:

Cambridge Plan



Having examined the Plans prepared by the Engineer and the Engineer's License, I hereby certify that the Plans comply with the laws of the State of Nebraska. This seal is covered by the seal.

Thomas C. Gaudet
Professional Engineer
License No. 44796
State of Nebraska

P-1

PROJECT
Stone Creek Village
7-Unit Townhome, Bldg AA
Cambridge Plan
Building Numbers: 1-7
Omaha, NE

BREWER ENGINEERING CONSULTANTS, P.C.
2705 82nd CONVENT RD, STE 111 - ANKENY, IOWA 50021
515-963-2222

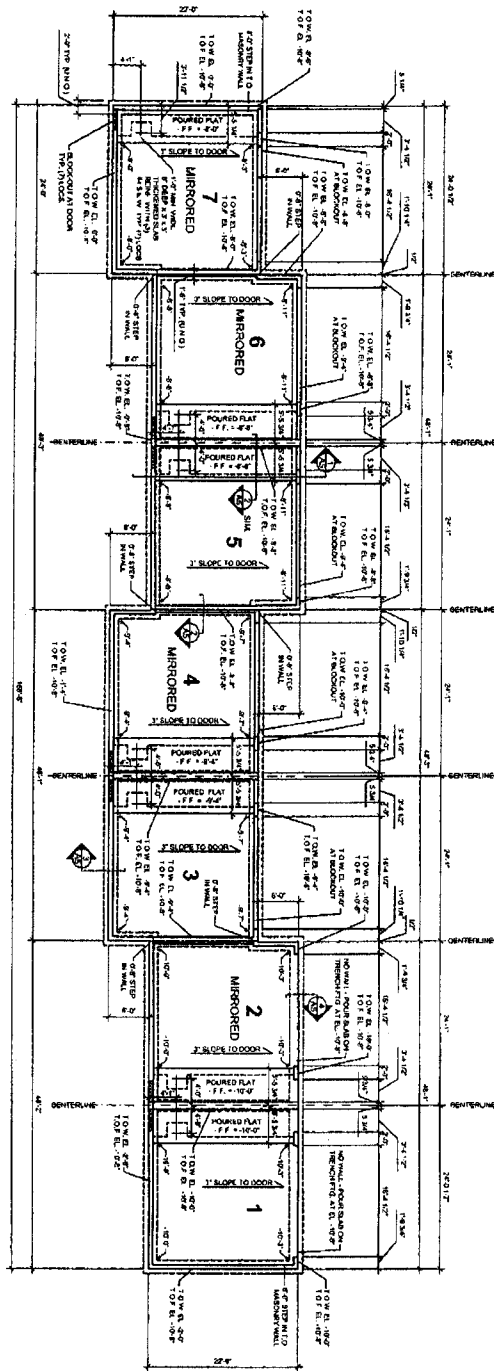

1 Foundation Plan
SCALE 1/8"=1'-0"



THIS FOUNDATION PLAN IS TO BE USED IN CONJUNCTION WITH THE ARCHITECTURAL DRAWINGS TO WHICH IT REFERS. IT IS THE RESPONSIBILITY OF THE ARCHITECT TO VERIFY THE ACCURACY OF ALL DIMENSIONS AND CONDITIONS SHOWN HEREON.

Reference Elevation
 4'-0" = 1242
 0'-0" = 1250

<p>S-1</p>	<p>PROJECT: Stone Creek Village 7-Unit Townhome, Block AA Cambridge Plan Building Numbers: 1-7 Omaha, NE</p>	<p>CERTIFICATION: I CERTIFY THAT THE SEALS AND SIGNATURES PREPARED BY ME OR UNDER MY DIRECT SUPERVISION AND THAT I AM A duly LICENSED ENGINEER UNDER THE LAWS OF THE STATE OF NEB.</p>	<p>JCorp, Inc. Consulting Engineers P.O. Box 118, Omaha, NE 68104 Phone (415) 884-8422 Fax (415) 881-0425 www.jcorp.com</p>	<p>TRITON HOMES, Inc. 1804 E. Delaware Ave. - Ste 1115 Omaha, NE 68105 www.triton-homes.com Ph: (415) 250-1200 Fax: (415) 951-0659</p>
	<p>DATE: 03/14/06 DRAWN BY: [unintelligible] CHECKED BY: [unintelligible] APPROVED BY: [unintelligible]</p>	<p>DATE: 03/14/06 DRAWN BY: [unintelligible] CHECKED BY: [unintelligible] APPROVED BY: [unintelligible]</p>	<p>DATE: 03/14/06 DRAWN BY: [unintelligible] CHECKED BY: [unintelligible] APPROVED BY: [unintelligible]</p>	<p>DATE: 03/14/06 DRAWN BY: [unintelligible] CHECKED BY: [unintelligible] APPROVED BY: [unintelligible]</p>

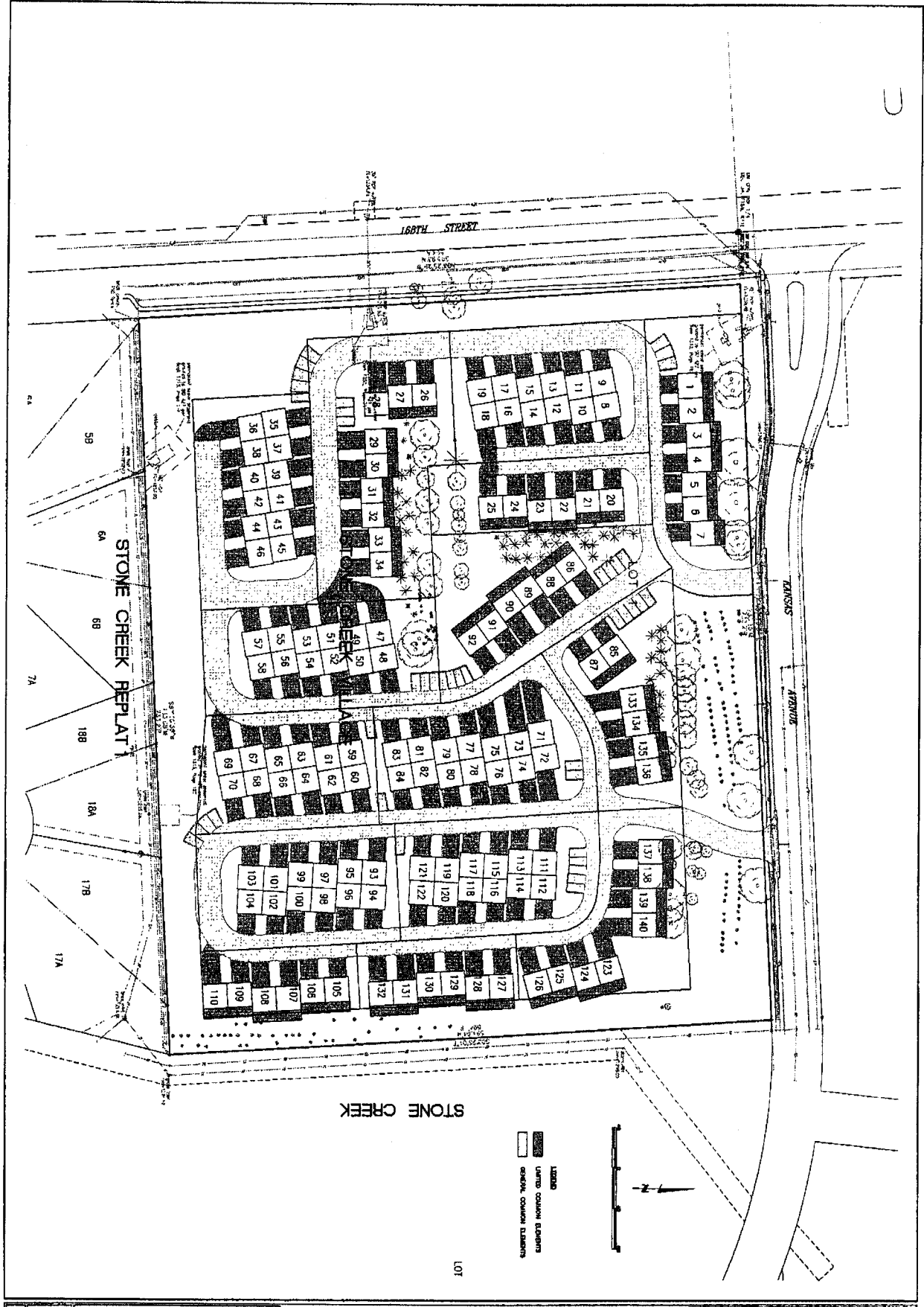

<p>1 of 1</p> <p>DATE: 05/20/01 DRAWN BY: [Name] CHECKED BY: [Name]</p>	<p>EXHIBIT C LIMITED & GENERAL COMMON ELEMENTS</p>	<p>Lamp, Rynearson & Associates, Inc. 14710 West Dodge Road, Suite 100 Omaha, Nebraska 68154-2027</p> <p>STONE CREEK VILLAGE DOUGLAS COUNTY, NEBRASKA</p>	<p>WWW.LRA-INC.COM</p> <p>(Ph) 402.496.2498 (Fax) 402.496.2730</p>
---	---	--	---

PROPOSED CONDOMINIUM PHASING PARCELS

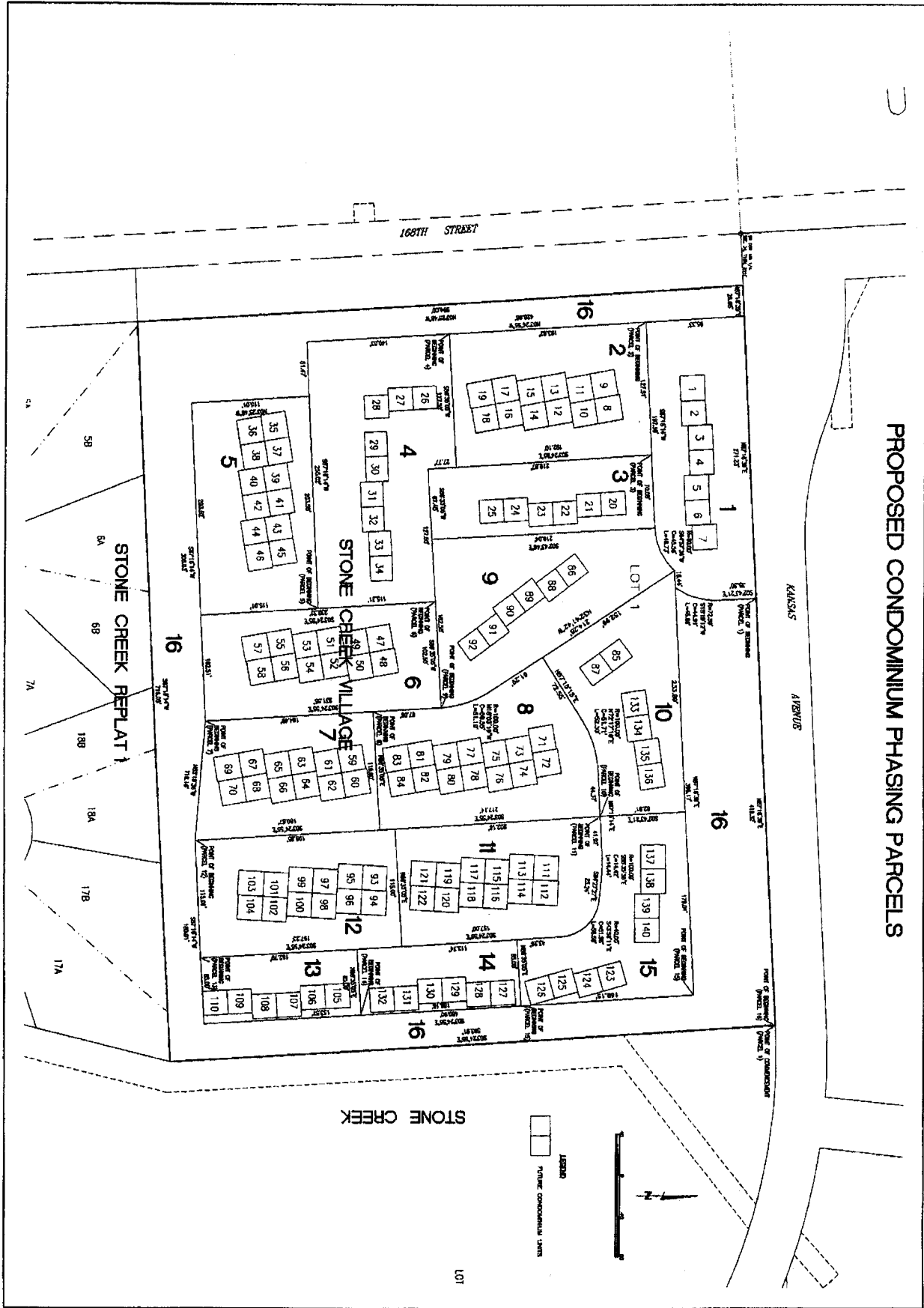

EXHIBIT C
PHASING EXHIBIT

Lamp, Ryneason & Associates, Inc. WWW.LRA-INC.COM
 14710 West Dodge Road, Suite 100 (78) 402.496.2498
 Omaha, Nebraska 68154-7027 (78) 402.496.2730

STONE CREEK VILLAGE
DOUGLAS COUNTY, NEBRASKA

DATE	1/11/2008
PROJECT	STONE CREEK VILLAGE
SCALE	AS SHOWN
BY	DAVID LAMP
CHECKED	DAVID LAMP
DATE	1/11/2008
APPROVED	DAVID LAMP
DATE	1/11/2008

CONDOMINIUM PHASING PARCELS

PARCEL 1 LEGAL DESCRIPTION

That part of Lot 1, STONE CREEK VILLAGE, a subdivision, as surveyed, platted and recorded in Douglas County, Nebraska, described as follows:

Commencing at the northeast corner of said Lot 1;

Thence South 87°16'39" West (bearings referenced to the Final Plat of STONE CREEK VILLAGE) for 416.32 feet along the north line of said Lot 1 to the TRUE POINT OF BEGINNING;

Thence South 02°43'21" East for 35.30 feet;

Thence along a curve to the right (having a radius of 72.50 feet and a long chord bearing South 15°19'12" West for 44.91 feet) for an arc length of 45.66 feet;

Thence South 87°16'39" West for 16.44 feet;

Thence along a curve to the right (having a radius of 60.00 feet and a long chord bearing South 64°57'36" West for 45.56 feet) for an arc length of 46.73 feet;

Thence South 87°16'14" West for 197.59 feet;

Thence North 03°24'55" West for 95.33 feet to the north line of said Lot 1;

Thence North 87°16'39" East for 271.23 feet to the Point of Beginning.

The total area of parcel 1 is 24,848.40 sq. ft. or 0.57 acre, more or less.

PARCEL 2 LEGAL DESCRIPTION

That part of Lot 1, STONE CREEK VILLAGE, a subdivision, as surveyed, platted and recorded in Douglas County, Nebraska, described as follows:

Beginning at the southwest corner of the above described Parcel 1;

Thence North 87°16'14" East (bearings referenced to the Final Plat of STONE CREEK VILLAGE) for 127.51 feet along the south line of said Parcel 1;

Thence South 03°24'55" East for 192.10 feet;

Thence South 86°35'05" West for 127.50 feet to the extended west line of said Parcel 1;

Thence North 03°24'55" West for 193.62 feet to the Point of Beginning.

The total area of parcel 2 is 24,589.79 sq. ft. or 0.56 acre, more or less.

PARCEL 3 LEGAL DESCRIPTION

That part of Lot 1, STONE CREEK VILLAGE, a subdivision, as surveyed, platted and recorded in Douglas County, Nebraska, described as follows:

Beginning at the northeast corner of the above described Parcel 2;

Thence North 87°16'14" East (bearings referenced to the Final Plat of STONE CREEK VILLAGE) for 70.08 feet along the south line of the above described Parcel 1;

Thence South 02°43'46" East for 219.04 feet;

Thence South 86°35'05" West for 67.45 feet to the extended east line of said Parcel 2;

Thence North 03°24'55" West for 219.87 feet to the Point of Beginning.

The total area of parcel 3 is 15,135.34 sq. ft. or 0.35 acre, more or less.

PARCEL 4 LEGAL DESCRIPTION

That part of Lot 1, STONE CREEK VILLAGE, a subdivision, as surveyed, platted and recorded in Douglas County, Nebraska, described as follows:

Beginning at the southwest corner of the above described Parcel 2;

Thence North 86°35'05" East (bearings referenced to the Final Plat of STONE CREEK VILLAGE) for 127.50 feet to the southeast corner of said Parcel 2 and the west line the above describe Parcel 3;

Thence South 03°24'55" East for 27.77 feet along said west line to the southwest corner of said Parcel 3;

Thence North 86°35'05" East for 127.50 feet along the south line of said Parcel 3 extended east;

Thence South 03°24'55" East for 115.31 feet;

Thence South 87°16'14" West for 255.02 feet to the extended west line of said Parcel 2;

Thence North 03°24'55" West for 140.03 feet to the Point of Beginning.

The total area of parcel 4 is 32,555.60 sq. ft. or 0.75 acre, more or less.

PARCEL 5 LEGAL DESCRIPTION

That part of Lot 1, STONE CREEK VILLAGE, a subdivision, as surveyed, platted and recorded in Douglas County, Nebraska, described as follows:

Beginning at the southeast corner of the above described Parcel 4;

Thence South 03°24'55" East (bearings referenced to the Final Plat of STONE CREEK VILLAGE) for 115.01 feet along the extended east line of said Parcel 4;

Thence South 87°16'14" West for 203.52 feet;

Thence North 03°25'48" West for 115.01 feet to the south line of said Parcel 4;

Thence North 87°16'14" East for 203.55 feet to the Point of Beginning.

The total area of parcel 5 is 23,406.62 sq. ft. or 0.54 acre, more or less.

PARCEL 6 LEGAL DESCRIPTION

That part of Lot 1, STONE CREEK VILLAGE, a subdivision, as surveyed, platted and recorded in Douglas County, Nebraska, described as follows:

Beginning at the northeast corner of the above described Parcel 4;

Thence North 86°35'05" East (bearings referenced to the Final Plat of STONE CREEK VILLAGE) for 102.50 feet along the extended north line of said Parcel 4;

Thence South 03°24'55" East for 231.55 feet to the extended south line of the above described Parcel 5;

Thence South 87°16'44" West for 102.51 feet to the southeast corner of said Parcel 5;

Thence North 03°24'55" West for 230.32 feet along the east line of said Parcels 4 and 5 to the Point of Beginning.

The total area of parcel 6 is 23,628.62 sq. ft. or 0.54 acre, more or less.

PARCEL 7 LEGAL DESCRIPTION

That part of Lot 1, STONE CREEK VILLAGE, a subdivision, as surveyed, platted and recorded in Douglas County, Nebraska, described as follows:

Beginning at the southeast corner of the above described Parcel 6;

Thence North 03°24'55" West (bearings referenced to the Final Plat of STONE CREEK

VILLAGE) for 164.49 feet along the east line of said Parcel 6;
 Thence North 86°35'05" East for 115.00 feet;
 Thence South 03°24'55" East for 180.87 feet;
 Thence North 85°18'36" West for 116.16 feet to the Point of Beginning.

The total area of parcel 7 is 19,858.07 sq. ft. or 0.46 acre, more or less.

PARCEL 8 LEGAL DESCRIPTION

That part of Lot 1, STONE CREEK VILLAGE, a subdivision, as surveyed, platted and recorded in Douglas County, Nebraska, described as follows:

Beginning at the northwest corner of the above described Parcel 7;
 Thence North 03°24'55" West (bearings referenced to the Final Plat of STONE CREEK VILLAGE) for 67.06 feet along the east line of the above described Parcel 6 to the northeast corner thereof;
 Thence along a curve to the left (having a radius of 100.00 feet and a long chord bearing North 18°03'19" West for 50.55 feet) for an arc length of 51.10 feet;
 Thence North 32°41'42" West for 61.29 feet;
 Thence North 57°18'18" East for 72.55 feet;
 Thence along a curve to the right (having a radius of 100.00 feet and a long chord bearing North 72°17'16" East for 51.71 feet) for an arc length of 52.30 feet;
 Thence North 87°16'14" East for 44.37 feet to the extended east line of said Parcel 7;
 Thence South 03°24'55" East for 217.14 feet to the northeast corner said Parcel 7;
 Thence South 86°35'05" West for 115.00 feet to the Point of Beginning.

The total area of parcel 8 is 26,641.65 sq. ft. or 0.61 acre, more or less.

PARCEL 9 LEGAL DESCRIPTION

That part of Lot 1, STONE CREEK VILLAGE, a subdivision, as surveyed, platted and recorded in Douglas County, Nebraska, described as follows:

Beginning at the northeast corner of the above described Parcel 6;
 Thence South 86°35'05" West (bearings referenced to the Final Plat of STONE CREEK VILLAGE) for 162.55 feet along the north line of the above described Parcels 4 and 6 to the southeast corner of the above described Parcel 3;
 Thence North 02°43'46" West for 219.04 feet to the northeast corner of said Parcel 3;
 Thence along a curve to the left (having a radius of 60.00 feet and a long chord bearing North 64°57'36" East for 45.56 feet) for an arc length of 46.73 feet along the south line of the above described Parcel 1;
 Thence South 32°41'42" East for 214.28 feet along the extended west line of the above described Parcel 8;
 Thence along a curve to the right (having a radius of 100.00 feet and a long chord bearing South 18°03'19" East for 50.55 feet) for an arc length of 51.10 feet along said west line to the Point of Beginning.

The total area of parcel 9 is 25,079.59 sq. ft. or 0.58 acre, more or less.

PARCEL 10 LEGAL DESCRIPTION

That part of Lot 1, STONE CREEK VILLAGE, a subdivision, as surveyed, platted and recorded in Douglas County, Nebraska, described as follows:

Beginning at the northeast corner of the above described Parcel 8;

Thence South 87°16'14" West (bearings referenced to the Final Plat of STONE CREEK VILLAGE) for 44.37 feet along the north line of the above described Parcel 8;

Thence along a curve to the left (having a radius of 100.00 feet and a long chord bearing South 72°17'16" West for 51.71 feet) for an arc length of 52.30 feet along said north line;

Thence South 57°18'18" West for 72.55 feet along said north line to the east line of the above described Parcel 9;

Thence North 32°41'42" West for 152.99 feet along said east line to the south line of above described Parcel 1;

Thence North 87°16'39" East for 233.89 feet along the extended south line of said Parcel 1;

Thence South 02°43'21" East for 82.91 feet to the Point of Beginning.

The total area of parcel 10 is 20,245.72 sq. ft. or 0.46 acre, more or less.

PARCEL 11 LEGAL DESCRIPTION

That part of Lot 1, STONE CREEK VILLAGE, a subdivision, as surveyed, platted and recorded in Douglas County, Nebraska, described as follows:

Beginning at the northeast corner of the above described Parcel 8;

Thence North 87°16'14" East (bearings referenced to the Final Plat of STONE CREEK VILLAGE) for 41.92 feet along the extended north line of said Parcel 8;

Thence along a curve to the right (having a radius of 100.00 feet and a long chord bearing South 88°35'36" East for 14.42 feet) for an arc length of 14.44 feet;

Thence South 84°27'27" East for 25.24 feet;

Thence along a curve to the right (having a radius of 40.00 feet and a long chord bearing South 43°56'11" East for 51.98 feet) for an arc length of 56.58 feet;

Thence South 03°24'55" East for 157.00 feet

Thence South 86°35'05" West for 115.00 feet to the east line of the above described Parcel 8;

Thence North 03°24'55" West for 202.16 feet to the Point of Beginning.

The total area of parcel 11 is 22,499.89 sq. ft. or 0.52 acre, more or less.

PARCEL 12 LEGAL DESCRIPTION

That part of Lot 1, STONE CREEK VILLAGE, a subdivision, as surveyed, platted and recorded in Douglas County, Nebraska, described as follows:

Beginning at the southeast corner of the above described Parcel 7;

Thence North 03°24'55" West (bearings referenced to the Final Plat of STONE CREEK VILLAGE) for 195.85 feet along the east line of the above described Parcels 7 and 8 to the southwest corner of above describe Parcel 11;

Thence North 86°35'05" East for 115.00 feet to the southeast corner of said Parcel 11;

Thence South 03°24'55" East for 197.23 feet;

Thence South 87°16'14" West for 115.01 feet to the Point of Beginning.

The total area of parcel 12 is 22,472.19 sq. ft. or 0.52 acre, more or less.

PARCEL 13 LEGAL DESCRIPTION

That part of Lot 1, STONE CREEK VILLAGE, a subdivision, as surveyed, platted and recorded in Douglas County, Nebraska, described as follows:

Beginning at the southeast corner of the above described Parcel 12;
 Thence North 03°24'55" West (bearings referenced to the Final Plat of STONE CREEK VILLAGE) for 152.79 feet along the east line of said Parcel 12;
 Thence North 86°35'05" East for 65.00 feet;
 Thence South 03°24'55" East for 153.57 feet to the extended south line of said Parcel 12;
 Thence South 87°16'14" West for 65.00 feet to the Point of Beginning.

The total area of parcel 13 is 9,956.71 sq. ft. or 0.23 acre, more or less.

PARCEL 14 LEGAL DESCRIPTION

That part of Lot 1, STONE CREEK VILLAGE, a subdivision, as surveyed, platted and recorded in Douglas County, Nebraska, described as follows:

Beginning at the northeast corner of the above described Parcel 13;
 Thence South 86°35'05" West (bearings referenced to the Final Plat of STONE CREEK VILLAGE) for 65.00 feet to the northwest corner of said Parcel 13 and the east line of the above described Parcel 12;
 Thence North 03°24'55" West for 113.74 feet along the east line of the above described Parcels 11 and 12;
 Thence North 86°35'05" East for 65.00 feet to the extended east line of said Parcel 13;
 Thence South 03°24'55" East for 158.18 feet to the Point of Beginning.

The total area of parcel 14 is 10,281.84 sq. ft. or 0.24 acre, more or less.

PARCEL 15 LEGAL DESCRIPTION

That part of Lot 1, STONE CREEK VILLAGE, a subdivision, as surveyed, platted and recorded in Douglas County, Nebraska, described as follows:

Beginning at the northeast corner of the above described Parcel 14;
 Thence South 86°35'05" West (bearings referenced to the Final Plat of STONE CREEK VILLAGE) for 65.00 feet to the northwest corner of said Parcel 14 and the east line of the above described Parcel 11;
 Thence North 03°24'55" West for 43.26 feet along said east line;
 Thence along a curve to the left (having a radius of 40.00 feet and a long chord bearing North 43°56'11" West for 51.98 feet) for an arc length of 56.58 feet along the east and north line of the above describe Parcel 11;
 Thence North 84°27'27" West for 25.24 feet along said north line;
 Thence along a curve to the left (having a radius of 100.00 feet and a long chord bearing North 88°35'36" West for 14.42 feet) for an arc length of 14.44 feet along said north line;
 Thence South 87°16'14" West for 41.92 feet along the north line of the above described Parcel 11 to the southeast corner of the above described Parcel 10;
 Thence North 02°43'21" West for 82.91 feet to the northeast corner of said Parcel 10;
 Thence North 87°16'39" East for 179.01 feet to the extended east line of said Parcel 14;
 Thence South 03°24'55" East for 169.15 feet to the Point of Beginning.

The total area of parcel 15 is 21,072.05 sq. ft. or 0.48 acre, more or less.

PARCEL 16 LEGAL DESCRIPTION

That part of Lot 1, STONE CREEK VILLAGE, a subdivision, as surveyed, platted and recorded in Douglas County, Nebraska, described as follows:

Beginning at the northeast corner of the said Lot 1;
Thence South $03^{\circ}24'55''$ East (bearings referenced to the Final Plat of STONE CREEK VILLAGE) for 593.91 feet to the southeast corner of said Lot 1;
Thence South $87^{\circ}16'14''$ West for 716.05 feet to the southwest corner of said Lot 1;
Thence North $03^{\circ}25'48''$ West for 594.00 feet to the northwest corner of said Lot 1;
Thence North $87^{\circ}16'39''$ East for 28.65 feet along the north line of said Lot 1 to the northwest corner of the above described Parcel 1;
Thence South $03^{\circ}24'55''$ East for 428.98 feet along the west line of the above described Parcels 1, 2 and 4 to the southwest corner of said Parcel 4;
Thence North $87^{\circ}16'14''$ East for 51.47 feet along the south line of said Parcel 4 to the northwest corner of the above described Parcel 5;
Thence South $03^{\circ}25'48''$ East for 115.01 feet to the southwest corner of said Parcel 5;
Thence North $87^{\circ}16'14''$ East for 306.03 feet along the south line of the above described Parcels 5 and 6 to the southeast corner of said Parcel 6;
Thence South $85^{\circ}18'36''$ East for 116.16 feet to the southwest corner of the above described Parcel 12;
Thence North $87^{\circ}16'14''$ East for 180.01 feet along the south line of the above described Parcels 12 and 13 to the southeast corner of said Parcel 13;
Thence North $03^{\circ}24'55''$ West for 480.90 feet along the east line of the above described Parcels 13, 14 and 15 to the northeast corner of said Parcel 15;
Thence South $87^{\circ}16'39''$ West for 396.17 feet along the north line of the above described Parcels 9, 10 and 15 to the east line of said Parcel 1;
Thence along a curve to the left (having a radius of 72.50 feet and a long chord bearing North $15^{\circ}19'12''$ East for 44.91 feet) for an arc length of 45.66 feet along said east line;
Thence North $02^{\circ}43'21''$ West for 35.30 feet along said east line to the north line of said Lot 1;
Thence North $87^{\circ}16'14''$ East for 416.32 feet to the Point of Beginning.

The total area of parcel 16 is 102,641.60 sq. ft. or 2.36 acres, more or less.

**EXHIBIT C
ALLOCATIONS**

Unit Number	Percentage
1	14.28571%
2	14.28571%
3	14.28571%
4	14.28571%
5	14.28571%
6	14.28571%
7	14.28571%

Pursuant to Section 2.1 of the Declaration and Master Deed of Stone Creek Village Condominium Property Regime, the above allocations are subject to recalculation upon the creation of any additional Units, the reallocation of the boundaries of any Units, the conversation of Units into Common Elements or the conversation of Common Elements to Units.

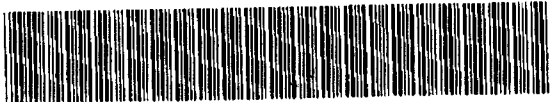

MISC 2006097485



AUG 24 2006 15:07 P 3

**AMENDMENT TO
DECLARATION AND MASTER DEED
OF STONE CREEK VILLAGE
CONDOMINIUM PROPERTY REGIME**

Received - DIANE L. BATTIATO
Register of Deeds, Douglas County, NE
8/24/2006 15:07:23.84



2006097485

This Amendment to Declaration and Master Deed of Stone Creek Village Condominium Property Regime (this "Amendment") is made and entered into this 11th day of August, 2006, by TRITON HOMES, L.C., an Iowa limited liability company, doing business in Nebraska as TRITON HOMES, LLC (hereinafter referred to as "Declarant") and the other Owners set forth below. This Amendment relates to the Declaration and Master Deed of Stone Creek Village Condominium Property Regime (the "Declaration"), which Declaration was dated June 7, 2006 and filed June 8, 2006 with the Register of Deeds of Douglas County, Nebraska at instrument number 2006064045 recorded against the real estate identified on Exhibit A attached hereto and incorporated herein by reference.

WHEREAS, the Declaration provides for certain pet restrictions in Section 8.2(a); and

WHEREAS, the Declarant, as the sole owner in the development, wishes to amend the Declaration relating to the pet restrictions:

NOW, THEREFORE, pursuant to the authority to amend the Declaration set forth in Article XIV of the Declaration, the Declarant, as the sole owner, hereby makes the following amendments to the Declaration:

1. Section 8.2(a) shall be deleted in its entirety and the following shall be inserted in lieu thereof:

No animals, livestock, or poultry of any kind shall be raised, bred, or kept on any lot except that dogs, cats, or other household pets may be kept, provided that they are not kept, bred, or maintained for any commercial purposes. Provided, however, that no pit bulls or Rottweilers shall be allowed in any case. In the event that any amendments are made to this Declaration which further restrict the keeping of pets, all pets that had existed at the time of such amendment shall be "grandfathered" and shall be allowed to remain in the living unit, provided, however, that no replacement pets acquired after the date of the amendment would be

Return to:
Mark J. LaPuzza
Pansing Hogan Ernst & Bachman LLP
10250 Regency Circle, Suite 300
Omaha, NE 68114

Misc
 FEE 15.50 FB 05-37088
 3 BKP _____ C/O _____ COMP B
 1 DEL _____ SCAN _____ FV _____

allowed if they violate any such amendment. All pets must be kept on a leash and each Owner shall be responsible for cleaning up all pet waste. Any damage done by any pets, including dragging chains, digging, scratching or chewing, shall be the responsibility of the owner of such pet, including, but not limited to, any such damage done to landscaping. No owner shall be allowed to chain or otherwise confine their pet in the common area at any time. The Association shall have the right to require removal of pets in the individual cases where such pets are or become legal nuisances and unreasonably disturb the quiet enjoyment of the Properties by the Owners. The Association may levy a Twenty-five Dollars (\$25.00) per incident fine for any pet waste that is not cleaned up by the owner of such pet.

DECLARANT:

TRITON HOMES, L.C., an Iowa limited liability company, doing business in Nebraska as TRITON HOMES, LLC

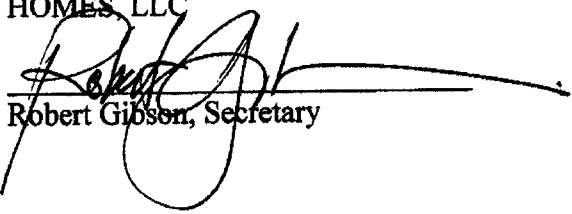
Robert Gibson, Secretary

STATE OF IOWA)
) ss.
COUNTY OF POLK)

The foregoing instrument was acknowledge before me this 11th day of Aug, 2006 by Robert Gibson, the Secretary of Triton Homes, L.C., an Iowa limited liability company, doing business in Nebraska as Triton Homes, LLC, on behalf of the company.

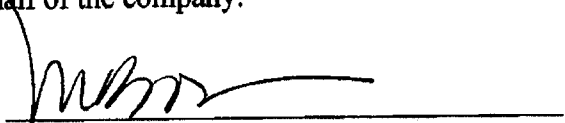
Notary Public



275340

**EXHIBIT A
LEGAL DESCRIPTION**

Lot 1, Stone Creek Village, a Subdivision, as surveyed, platted and recorded in Douglas County, Nebraska.



MISC 2006109651



SEP 22 2006 15:15 P 2

**AMENDMENT TO
DECLARATION AND MASTER DEED
OF STONE CREEK VILLAGE
CONDOMINIUM PROPERTY REGIME**

Received - DIANE L. BATTIATO
Register of Deeds, Douglas County, NE
9/22/2006 15:15:07.45



2006109651

This Amendment to Declaration and Master Deed of Stone Creek Village Condominium Property Regime (this "Amendment") is made and entered into this 15th day of September, 2006, by TRITON HOMES, L.C., an Iowa limited liability company, doing business in Nebraska as TRITON HOMES, LLC (hereinafter referred to as "Declarant"). This Amendment relates to the Declaration and Master Deed of Stone Creek Village Condominium Property Regime dated June 7, 2006 and filed June 8, 2006 with the Register of Deeds of Douglas County, Nebraska at instrument number 2006064045, as amended by Amendment to Declaration and Master Deed of Stone Creek Village Condominium Property Regime dated August 11, 2006 and filed August 24, 2006 with the Register of Deeds of Douglas County, Nebraska at instrument number 2006097485 (the "Declaration").

WHEREAS, the Declaration is recorded against the real property legally described as follows:

Lot 1, Stone Creek Village, a subdivision, as surveyed, platted and recorded in Douglas County, Nebraska

(the "Condominium");

WHEREAS, the Declarant is the sole owner of Units in the Condominium, and has the authority to amend the Declaration;

WHEREAS, the Declarant is expressly authorized by Section 15.3 of the Declaration to amend the Declaration to comply with the requirements of the Department of Housing and Urban Development ("HUD");

WHEREAS, the Declarant has been advised by HUD that language contained in Section 8.8(c) of the Declaration is not in compliance with HUD regulations;

WHEREAS, the Declarant has determined that it is in the best interest of the Condominium to amend the Declaration to comply with requests made by HUD;

RETURN: Parsipua Hogan ERNST+BACHMAN LLP
10250 Regency Circle Suite 300
Omaha, NE 68114

5 misc
FEE 10.50 FB OJ-37088
2
BKP C/O COMP BV
1 DEL SCAN EV

NOW, THEREFORE, pursuant to the authority to amend the Declaration set forth in Articles XIV and XV of the Declaration, the Declarant, as the sole owner, hereby makes the following amendments to the Declaration:

- 1. Section 8.8(c) shall be deleted in its entirety and replaced in full as follows:

8.8(c) A fully executed copy of such lease or sublease shall be furnished to the Board not less than thirty (30) days prior to the date the lessee or sublessee is to obtain possession of the Unit.

- 2. Except as expressly set forth herein, and as amended by previous and subsequent duly-recorded amendments thereto, the Declaration shall continue in full force and effect.

DECLARANT:

TRITON HOMES, L.C., an Iowa limited liability company, doing business in Nebraska as TRITON HOMES, LLC

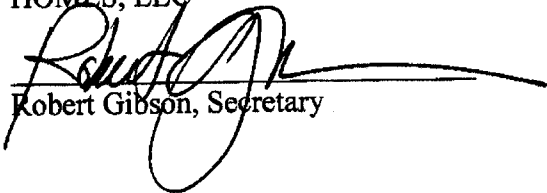
 Robert Gibson, Secretary

STATE OF IOWA)
) ss.
 COUNTY OF POLK)

The foregoing instrument was acknowledge before me this 15th day of September, 2006 by Robert Gibson, the Secretary of Triton Homes, L.C., an Iowa limited liability company, doing business in Nebraska as Triton Homes, LLC, on behalf of the company.

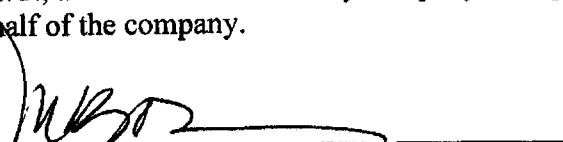
 Notary Public





MISC 2006131643



NOV 17 2006 12:11 P 3

**THIRD AMENDMENT TO
DECLARATION AND MASTER DEED
OF STONE CREEK VILLAGE
CONDOMINIUM PROPERTY REGIME**

Received - DIANE L. BATTIATO
Register of Deeds, Douglas County, NE
11/17/2006 12:11:08.50



2006131643

This Third Amendment to Declaration and Master Deed of Stone Creek Village Condominium Property Regime (this "Amendment") is made this 16 day of November, 2006, by Triton Homes, L.C., an Iowa limited liability company, doing business in Nebraska as Triton Homes, LLC, hereinafter referred to as the "Declarant", also being sole owner of the real estate subject to the Declaration and Master Deed of Stone Creek Village Condominium Property Regime dated June 7, 2006 and filed June 8, 2006 with the Register of Deeds of Douglas County, Nebraska at instrument number 2006064045, as amended by Amendment to Declaration and Master Deed of Stone Creek Village Condominium Property Regime dated August 11, 2006 and filed August 24, 2006 with the Register of Deeds of Douglas County, Nebraska at instrument number 2006097485, as further amended by Amendment to Declaration and Master Deed of Stone Creek Village Condominium Property Regime dated September 15, 2006 and filed September 22, 2006 with the Register of Deeds of Douglas County, Nebraska at instrument number 2006109651 (the "Declaration").

PRELIMINARY STATEMENT

WHEREAS, the Declarant is the Declarant under the Declaration and is the sole owner of the real estate subject to the Declaration, legally described as follows:

Lot 1, Stone Creek Village, a subdivision, as surveyed, platted and recorded in Douglas County, Nebraska;

WHEREAS, the Declarant, pursuant to Section 2.1 of the Declaration is granted the right and power to add additional units to the Stone Creek Village Condominium Property Regime (the "Condominium");

WHEREAS, the Declarant wishes to subject to the Declaration phase 3, as legally described and pictorially identified in the Plans attached to the Declaration as Exhibit "B"; and

WHEREAS, the Declarant desires to amend Exhibit "C" to the Declaration to reflect the addition of such phase 3;

MISC
FEE 21.50 FB _____
B $\frac{w}{13}$ BKP _____ C/O _____ COMP g
DEL _____ SCAN _____ FV _____
©

NOW, THEREFORE, the Declarant, pursuant to the rights granted to it under Section 2.1 of the Declaration, hereby amends the Declaration in the following particulars:

1. Exhibit "C" of the Declaration is hereby replaced in its entirety by the attached Allocations, identified as Exhibit "C" hereto and incorporated herein by reference.

2. The addition of phase3 and the Units contained therein, are, by this Amendment, authorized for creation and addition to the Declaration, and the Owners of the Units in such phases are hereby granted rights as Unit Owners in the Condominium and members of the Village at Falcon Ridge Condominium Association, a Nebraska not-for-profit corporation.

3. Except as expressly amended herein, the terms and conditions of the Declaration shall continue in full force and effect.

Dated this 16 day of November, 2006.

DECLARANT:

TRITON HOMES, L.C., an Iowa limited liability company, doing business in Nebraska as TRITON HOMES, LLC

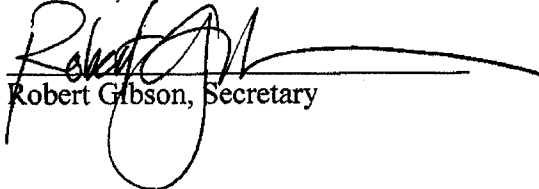
Robert Gibson, Secretary

STATE OF IOWA)
) ss.
COUNTY OF POLK)

The foregoing instrument was acknowledge before me this 16th day of November, 2006 by Robert Gibson, the Secretary of Triton Homes, L.C., an Iowa limited liability company, doing business in Nebraska as Triton Homes, LLC, on behalf of the company.





Notary Public

**EXHIBIT C
ALLOCATIONS**

Unit Number	Percentage
1	7.69%
2	7.69%
3	7.69%
4	7.69%
5	7.69%
6	7.69%
7	7.69%
20	7.69%
21	7.69%
22	7.69%
23	7.69%
24	7.69%
25	7.69%

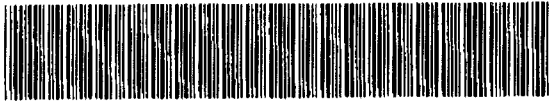
Pursuant to Section 2.1 of the Declaration and Master Deed of Stone Creek Village Condominium Property Regime, the above allocations are subject to recalculation upon the creation of any additional Units, the reallocation of the boundaries of any Units, the conversion of Units into Common Elements or the conversion of Common Elements to Units.



MISC 2007046751



APR 26 2007 15:02 P 3

Received - DIANE L. BATTIATO
Register of Deeds, Douglas County, NE

4/26/2007 15:02:47.91



2007046751

**FOURTH AMENDMENT TO
DECLARATION AND MASTER DEED
OF STONE CREEK VILLAGE
CONDOMINIUM PROPERTY REGIME**

This Fourth Amendment to Declaration and Master Deed of Stone Creek Village Condominium Property Regime (this "Amendment") is made this 19 day of April, 2007, by Triton Homes, L.C., an Iowa limited liability company, doing business in Nebraska as Triton Homes, LLC, hereinafter referred to as the "Declarant", also being sole owner of the real estate subject to the Declaration and Master Deed of Stone Creek Village Condominium Property Regime dated June 7, 2006 and filed June 8, 2006 with the Register of Deeds of Douglas County, Nebraska at instrument number 2006064045, as amended by Amendment to Declaration and Master Deed of Stone Creek Village Condominium Property Regime dated August 11, 2006 and filed August 24, 2006 with the Register of Deeds of Douglas County, Nebraska at instrument number 2006097485, as further amended by Amendment to Declaration and Master Deed of Stone Creek Village Condominium Property Regime dated September 15, 2006 and filed September 22, 2006 with the Register of Deeds of Douglas County, Nebraska at instrument number 2006109651, as further amended by Third Amendment to Declaration and Master Deed of Stone Creek Village Condominium Property Regime dated November 16, 2006 and filed November 17, 2006 with the Register of Deeds of Douglas County, Nebraska at instrument number 2006131643 (the "Declaration").

PRELIMINARY STATEMENT

WHEREAS, the Declarant is the Declarant under the Declaration and is the sole owner of the real estate subject to the Declaration, legally described as follows:

Lot 1, Stone Creek Village, a subdivision, as surveyed, platted and recorded in Douglas County, Nebraska;

WHEREAS, the Declarant, pursuant to Section 2.1 of the Declaration is granted the right and power to add additional units to the Stone Creek Village Condominium Property Regime (the "Condominium");

WHEREAS, the Declarant wishes to subject to the Declaration phases 2 and 4, as legally described and pictorially identified in the Plans attached to the Declaration as Exhibit "B"; and

*Pansing Hogan ERNST & Bachmann LLP
10250 Regency CR Ste 300
Omaha NE 68114-6905*

*Misc 3250
3/34*

FEE	3250	FB	
BKP		C/O	COMP MB
DEL		SCAN	FV

05-37088

WHEREAS, the Declarant desires to amend Exhibit "C" to the Declaration to reflect the addition of such phases 2 and 4;

NOW, THEREFORE, the Declarant, pursuant to the rights granted to it under Section 2.1 of the Declaration, hereby amends the Declaration in the following particulars:

- 1. Exhibit "C" of the Declaration is hereby replaced in its entirety by the attached Allocations, identified as Exhibit "C" hereto and incorporated herein by reference.
- 2. The addition of phases 2 and 4 and the Units contained therein, are, by this Amendment, authorized for creation and addition to the Declaration, and the Owners of the Units in such phases are hereby granted rights as Unit Owners in the Condominium and members of the Village at Falcon Ridge Condominium Association, a Nebraska not-for-profit corporation.
- 3. Except as expressly amended herein, the terms and conditions of the Declaration shall continue in full force and effect.

Dated this 19 day of April, 2007.

DECLARANT:

TRITON HOMES, L.C., an Iowa limited liability company, doing business in Nebraska as TRITON HOMES, LLC

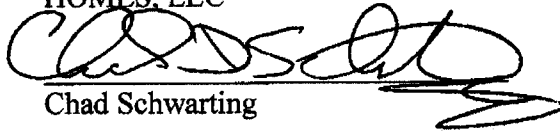
Chad Schwarting

STATE OF IOWA)
) ss.
COUNTY OF POLK)

The foregoing instrument was acknowledge before me this 19 day of April, 2007 by Chad Schwarting of Triton Homes, L.C., an Iowa limited liability company, doing business in Nebraska as Triton Homes, LLC, on behalf of the company.



Notary Public



**EXHIBIT C
ALLOCATIONS**

Unit Number	Percentage
1	2.941%
2	2.941%
3	2.941%
4	2.941%
5	2.941%
6	2.941%
7	2.941%
8	2.941%
9	2.941%
10	2.941%
11	2.941%
12	2.941%
13	2.941%
14	2.941%
15	2.941%
16	2.941%
17	2.941%
18	2.941%
19	2.941%
20	2.941%
21	2.941%
22	2.941%
23	2.941%
24	2.941%
25	2.941%
26	2.941%
27	2.941%
28	2.941%
29	2.941%
30	2.941%
31	2.941%
32	2.941%
33	2.941%
34	2.941%

Pursuant to Section 2.1 of the Declaration and Master Deed of Stone Creek Village Condominium Property Regime, the above allocations are subject to recalculation upon the creation of any additional Units, the reallocation of the boundaries of any Units, the conversation of Units into Common Elements or the conversation of Common Elements to Units.



MISC 2007061092



MAY 31 2007 14:59 P 4

**FIFTH AMENDMENT TO
DECLARATION AND MASTER DEED
OF STONE CREEK VILLAGE
CONDOMINIUM PROPERTY REGIME**

Received - DIANE L. BATTIATO
Register of Deeds, Douglas County, NE
5/31/2007 14:59:49.10



2007061092

This Fourth Amendment to Declaration and Master Deed of Stone Creek Village Condominium Property Regime (this "Amendment") is made this 22 day of May, 2007, by Triton Homes, L.C., an Iowa limited liability company, doing business in Nebraska as Triton Homes, LLC, hereinafter referred to as the "Declarant", also being sole owner of the real estate subject to the Declaration and Master Deed of Stone Creek Village Condominium Property Regime dated June 7, 2006 and filed June 8, 2006 with the Register of Deeds of Douglas County, Nebraska at instrument number 2006064045, as amended by Amendment to Declaration and Master Deed of Stone Creek Village Condominium Property Regime dated August 11, 2006 and filed August 24, 2006 with the Register of Deeds of Douglas County, Nebraska at instrument number 2006097485, as further amended by Amendment to Declaration and Master Deed of Stone Creek Village Condominium Property Regime dated September 15, 2006 and filed September 22, 2006 with the Register of Deeds of Douglas County, Nebraska at instrument number 2006109651, as further amended by Third Amendment to Declaration and Master Deed of Stone Creek Village Condominium Property Regime dated November 16, 2006 and filed November 17, 2006 with the Register of Deeds of Douglas County, Nebraska at instrument number 2006131643, as further amended by Fourth Amendment to Declaration and Master Deed of Stone Creek Village Condominium Property Regime dated April 19, 2007 and filed April 26, 2007 with the Register of Deeds of Douglas County, Nebraska at instrument number 2007046751 (the "Declaration").

PRELIMINARY STATEMENT

WHEREAS, the Declarant is the Declarant under the Declaration and is the sole owner of the real estate subject to the Declaration, legally described as follows:

Lot 1, Stone Creek Village, a subdivision, as surveyed, platted and recorded in Douglas County, Nebraska;

WHEREAS, the Declarant, pursuant to Section 2.1 of the Declaration is granted the right and power to add additional units to the Stone Creek Village Condominium Property Regime (the "Condominium");

RETURN: Pamela Hogan Ernst & Bachman
10250 Regency Cir. Suite 300
Omaha, NE 68114

misc
FEE 49.00 FB 05-37088
BKP _____ C/O _____ COMP BW
58 DEL _____ SCAN _____ FV _____

WHEREAS, the Declarant wishes to subject to the Declaration phases 5, 9 and 10, as legally described and pictorially identified in the Plans attached to the Declaration as Exhibit "B"; and

WHEREAS, the Declarant desires to amend Exhibit "C" to the Declaration to reflect the addition of such phases 5, 9 and 10;

NOW, THEREFORE, the Declarant, pursuant to the rights granted to it under Section 2.1 of the Declaration, hereby amends the Declaration in the following particulars:

- 1. Exhibit "C" of the Declaration is hereby replaced in its entirety by the attached Allocations, identified as Exhibit "C" hereto and incorporated herein by reference.
- 2. The addition of phases 5, 9 and 10 and the Units contained therein, are, by this Amendment, authorized for creation and addition to the Declaration, and the Owners of the Units in such phases are hereby granted rights as Unit Owners in the Condominium and members of the Village at Falcon Ridge Condominium Association, a Nebraska not-for-profit corporation.
- 3. Except as expressly amended herein, the terms and conditions of the Declaration shall continue in full force and effect.

Dated this 22 day of May, 2007.

DECLARANT:

TRITON HOMES, L.C., an Iowa limited liability company, doing business in Nebraska as TRITON HOMES, LLC

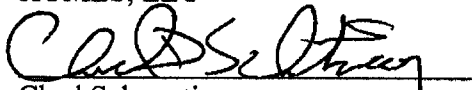
Chad Schwarting

STATE OF IOWA)
) ss.
COUNTY OF POLK)

The foregoing instrument was acknowledge before me this 22 day of May, 2007 by Chad Schwarting of Triton Homes, L.C., an Iowa limited liability company, doing business in Nebraska as Triton Homes, LLC, on behalf of the company.

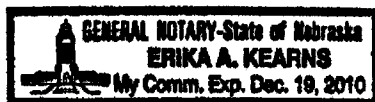

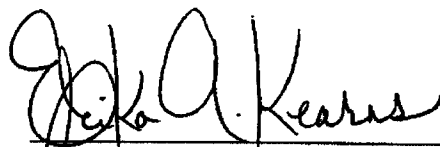
Notary Public

**EXHIBIT C
ALLOCATIONS**

<u>Unit Number</u>	<u>Percentage</u>
1	1.7241%
2	1.7241%
3	1.7241%
4	1.7241%
5	1.7241%
6	1.7241%
7	1.7241%
8	1.7241%
9	1.7241%
10	1.7241%
11	1.7241%
12	1.7241%
13	1.7241%
14	1.7241%
15	1.7241%
16	1.7241%
17	1.7241%
18	1.7241%
19	1.7241%
20	1.7241%
21	1.7241%
22	1.7241%
23	1.7241%
24	1.7241%
25	1.7241%
26	1.7241%
27	1.7241%
28	1.7241%
29	1.7241%
30	1.7241%
31	1.7241%
32	1.7241%
33	1.7241%
34	1.7241%
35	1.7241%
36	1.7241%
37	1.7241%
38	1.7241%
39	1.7241%
40	1.7241%

41	1.7241%
42	1.7241%
43	1.7241%
44	1.7241%
45	1.7241%
46	1.7241%
85	1.7241%
86	1.7241%
87	1.7241%
88	1.7241%
89	1.7241%
90	1.7241%
91	1.7241%
92	1.7241%
133	1.7241%
134	1.7241%
135	1.7241%
136	1.7241%

Pursuant to Section 2.1 of the Declaration and Master Deed of Stone Creek Village Condominium Property Regime, the above allocations are subject to recalculation upon the creation of any additional Units, the reallocation of the boundaries of any Units, the conversion of Units into Common Elements or the conversion of Common Elements to Units.



MISC 2007110277

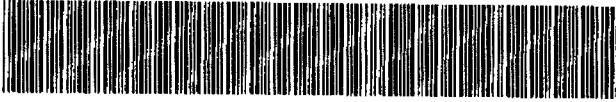

SEP 27 2007 12:22 P 4

misc

55.00 18 07-37089

B 4/70
SER _____ C/O _____ COMP *26*
DE. _____ SCAN _____ FY _____

**SIXTH AMENDMENT TO
DECLARATION AND MASTER DEED
OF STONE CREEK VILLAGE
CONDOMINIUM PROPERTY REGIME**

Received - DIANE L. BATTIATO
Register of Deeds, Douglas County, NE
9/27/2007 12:22:17.64



2007110277

This Sixth Amendment to Declaration and Master Deed of Stone Creek Village Condominium Property Regime (this "Amendment") is made this 26 day of September, 2007, by Triton Homes, L.C., an Iowa limited liability company, doing business in Nebraska as Triton Homes, LLC, hereinafter referred to as the "Declarant", also being sole owner of the real estate subject to the Declaration and Master Deed of Stone Creek Village Condominium Property Regime dated June 7, 2006 and filed June 8, 2006 with the Register of Deeds of Douglas County, Nebraska at instrument number 2006064045, as amended by Amendment to Declaration and Master Deed of Stone Creek Village Condominium Property Regime dated August 11, 2006 and filed August 24, 2006 with the Register of Deeds of Douglas County, Nebraska at instrument number 2006097485, as further amended by Amendment to Declaration and Master Deed of Stone Creek Village Condominium Property Regime dated September 15, 2006 and filed September 22, 2006 with the Register of Deeds of Douglas County, Nebraska at instrument number 2006109651, as further amended by Third Amendment to Declaration and Master Deed of Stone Creek Village Condominium Property Regime dated November 16, 2006 and filed November 17, 2006 with the Register of Deeds of Douglas County, Nebraska at instrument number 2006131643, as further amended by Fourth Amendment to Declaration and Master Deed of Stone Creek Village Condominium Property Regime dated April 19, 2007 and filed April 26, 2007 with the Register of Deeds of Douglas County, Nebraska at instrument number 2007046751, as further amended by Fifth Amendment to Declaration and Master Deed of Stone Creek Village Condominium Property Regime dated May 22, 2007 and filed May 31, 2007 with the Register of Deeds of Douglas County, Nebraska at instrument number 2007061092 (the "Declaration").

PRELIMINARY STATEMENT

WHEREAS, the Declarant is the Declarant under the Declaration and is the sole owner of the real estate subject to the Declaration, legally described as follows:

Lot 1, Stone Creek Village, a subdivision, as surveyed, platted and recorded in Douglas County, Nebraska;

ⓐ

WHEREAS, the Declarant, pursuant to Section 2.1 of the Declaration is granted the right and power to add additional units to the Stone Creek Village Condominium Property Regime (the "Condominium");

WHEREAS, the Declarant wishes to subject to the Declaration phase 6, as legally described and pictorially identified in the Plans attached to the Declaration as Exhibit "B"; and

WHEREAS, the Declarant desires to amend Exhibit "C" to the Declaration to reflect the addition of such phase 6;

NOW, THEREFORE, the Declarant, pursuant to the rights granted to it under Section 2.1 of the Declaration, hereby amends the Declaration in the following particulars:

1. Exhibit "C" of the Declaration is hereby replaced in its entirety by the attached Allocations, identified as Exhibit "C" hereto and incorporated herein by reference.

2. The addition of phase 6 and the Units contained therein, are, by this Amendment, authorized for creation and addition to the Declaration, and the Owners of the Units in such phases are hereby granted rights as Unit Owners in the Condominium and members of the Village at Falcon Ridge Condominium Association, a Nebraska not-for-profit corporation.

3. Except as expressly amended herein, the terms and conditions of the Declaration shall continue in full force and effect.

Dated this 26 day of September, 2007.

DECLARANT:

TRITON HOMES, L.C., an Iowa limited liability company, doing business in Nebraska as TRITON HOMES, LLC

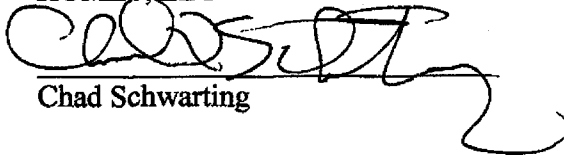

Chad Schwarting

CMR

NEBRASKA
STATE OF IOWA)
) ss.

COUNTY OF POLK)
DOUGLAS CMR

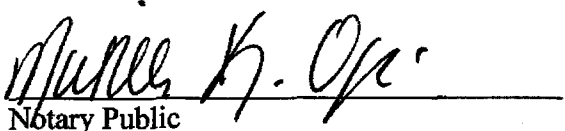
The foregoing instrument was acknowledge before me this 26 day of September, 2007 by Chad Schwarting of Triton Homes, L.C., an Iowa limited liability company, dbing business in Nebraska as Triton Homes, LLC, on behalf of the company.

Notary Public



**EXHIBIT C
ALLOCATIONS**

Unit Number	Percentage
1	1.4285%
2	1.4285%
3	1.4285%
4	1.4285%
5	1.4285%
6	1.4285%
7	1.4285%
8	1.4285%
9	1.4285%
10	1.4285%
11	1.4285%
12	1.4285%
13	1.4285%
14	1.4285%
15	1.4285%
16	1.4285%
17	1.4285%
18	1.4285%
19	1.4285%
20	1.4285%
21	1.4285%
22	1.4285%
23	1.4285%
24	1.4285%
25	1.4285%
26	1.4285%
27	1.4285%
28	1.4285%
29	1.4285%
30	1.4285%
31	1.4285%
32	1.4285%
33	1.4285%
34	1.4285%
35	1.4285%
36	1.4285%
37	1.4285%
38	1.4285%
39	1.4285%
40	1.4285%

41	1.4285%
42	1.4285%
43	1.4285%
44	1.4285%
45	1.4285%
46	1.4285%
47	1.4285%
48	1.4285%
49	1.4285%
50	1.4285%
51	1.4285%
52	1.4285%
53	1.4285%
54	1.4285%
55	1.4285%
56	1.4285%
57	1.4285%
58	1.4285%
85	1.4285%
86	1.4285%
87	1.4285%
88	1.4285%
89	1.4285%
90	1.4285%
91	1.4285%
92	1.4285%
133	1.4285%
134	1.4285%
135	1.4285%
136	1.4285%

Pursuant to Section 2.1 of the Declaration and Master Deed of Stone Creek Village Condominium Property Regime, the above allocations are subject to recalculation upon the creation of any additional Units, the reallocation of the boundaries of any Units, the conversation of Units into Common Elements or the conversation of Common Elements to Units.



MISC 2008047717



MAY 14 2008 15:14 P 6

B
 6 FEE Misl. 71.00 FB 05-37089
 BKP _____ C/O _____ COMP 72
 82 DEL _____ SCAN _____ FV _____

Received - DIANE L. BATTIATO
 Register of Deeds, Douglas County, NE
 5/14/2008 15:14:23.40

 2008047717

**SEVENTH AMENDMENT TO
 DECLARATION AND MASTER DEED
 OF STONE CREEK VILLAGE
 CONDOMINIUM PROPERTY REGIME**

This Seventh Amendment to Declaration and Master Deed of Stone Creek Village Condominium Property Regime (this "Amendment") is made this 7 day of May, 2008, by Triton Homes, L.C., an Iowa limited liability company, doing business in Nebraska as Triton Homes, LLC, hereinafter referred to as the "Declarant", also being sole owner of the real estate subject to the Declaration and Master Deed of Stone Creek Village Condominium Property Regime dated June 7, 2006 and filed June 8, 2006 with the Register of Deeds of Douglas County, Nebraska at instrument number 2006064045, as amended by Amendment to Declaration and Master Deed of Stone Creek Village Condominium Property Regime dated August 11, 2006 and filed August 24, 2006 with the Register of Deeds of Douglas County, Nebraska at instrument number 2006097485, as further amended by Amendment to Declaration and Master Deed of Stone Creek Village Condominium Property Regime dated September 15, 2006 and filed September 22, 2006 with the Register of Deeds of Douglas County, Nebraska at instrument number 2006109651, as further amended by Third Amendment to Declaration and Master Deed of Stone Creek Village Condominium Property Regime dated November 16, 2006 and filed November 17, 2006 with the Register of Deeds of Douglas County, Nebraska at instrument number 2006131643, as further amended by Fourth Amendment to Declaration and Master Deed of Stone Creek Village Condominium Property Regime dated April 19, 2007 and filed April 26, 2007 with the Register of Deeds of Douglas County, Nebraska at instrument number 2007046751, as further amended by Fifth Amendment to Declaration and Master Deed of Stone Creek Village Condominium Property Regime dated May 22, 2007 and filed May 31, 2007 with the Register of Deeds of Douglas County, Nebraska at instrument number 2007061092, as further amended by Sixth Amendment to Declaration and Master Deed of Stone Creek Village Condominium Property Regime dated September 26, 2007, and filed September 27, 2007 with the Register of Deeds of Douglas County, Nebraska at instrument number 2007110277 (the "Declaration").

PRELIMINARY STATEMENT

WHEREAS, the Declarant is the Declarant under the Declaration and is the sole owner of the real estate subject to the Declaration, legally described as follows:

DANSI. ✓ 7549

✓ 7549

Lot 1, Stone Creek Village, a subdivision, as surveyed, platted and recorded in Douglas County, Nebraska;

WHEREAS, the Declarant, pursuant to Section 2.1 of the Declaration is granted the right and power to add additional units to the Stone Creek Village Condominium Property Regime (the "Condominium");

WHEREAS, the Declarant wishes to subject to the Declaration phases 13 and 14, as legally described and pictorially identified in the Plans attached to the Declaration as Exhibit "B"; and

WHEREAS, the Declarant desires to amend Exhibit "C" to the Declaration to reflect the addition of such phases 13 and 14;

NOW, THEREFORE, the Declarant, pursuant to the rights granted to it under Section 2.1 of the Declaration, hereby amends the Declaration in the following particulars:

- 1. Exhibit "C" of the Declaration is hereby replaced in its entirety by the attached Allocations, identified as Exhibit "C" hereto and incorporated herein by reference.
- 2. The addition of phases 13 and 14 and the Units contained therein, are, by this Amendment, authorized for creation and addition to the Declaration, and the Owners of the Units in such phases are hereby granted rights as Unit Owners in the Condominium and members of the Village at Falcon Ridge Condominium Association, a Nebraska not-for-profit corporation.
- 3. Except as expressly amended herein, the terms and conditions of the Declaration shall continue in full force and effect.

Dated this 7 day of May, 2008.

DECLARANT:

TRITON HOMES, L.C., an Iowa limited liability company, doing business in Nebraska as TRITON HOMES, LLC

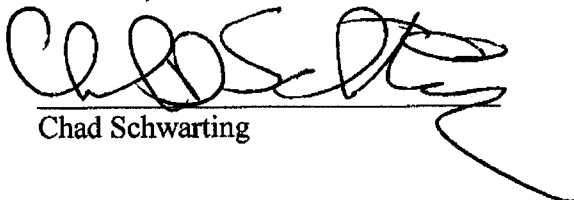

Chad Schwarting

STATE OF NEBRASKA)
) ss.
COUNTY OF DOUGLAS)

The foregoing instrument was acknowledge before me this 7th day of May, 2008 by Chad Schwarting of Triton Homes, L.C., an Iowa limited liability company, doing business in Nebraska as Triton Homes, LLC, on behalf of the company.

April L. McLaughlin
Notary Public

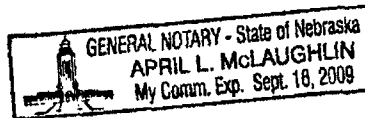

**EXHIBIT C
ALLOCATIONS**

<u>Unit Number</u>	<u>Percentage</u>
1	1.2195%
2	1.2195%
3	1.2195%
4	1.2195%
5	1.2195%
6	1.2195%
7	1.2195%
8	1.2195%
9	1.2195%
10	1.2195%
11	1.2195%
12	1.2195%
13	1.2195%
14	1.2195%
15	1.2195%
16	1.2195%
17	1.2195%
18	1.2195%
19	1.2195%
20	1.2195%
21	1.2195%
22	1.2195%
23	1.2195%
24	1.2195%
25	1.2195%
26	1.2195%
27	1.2195%
28	1.2195%
29	1.2195%
30	1.2195%
31	1.2195%
32	1.2195%
33	1.2195%
34	1.2195%
35	1.2195%
36	1.2195%
37	1.2195%
38	1.2195%
39	1.2195%
40	1.2195%

41	1.2195%
42	1.2195%
43	1.2195%
44	1.2195%
45	1.2195%
46	1.2195%
47	1.2195%
48	1.2195%
49	1.2195%
50	1.2195%
51	1.2195%
52	1.2195%
53	1.2195%
54	1.2195%
55	1.2195%
56	1.2195%
57	1.2195%
58	1.2195%
85	1.2195%
86	1.2195%
87	1.2195%
88	1.2195%
89	1.2195%
90	1.2195%
91	1.2195%
92	1.2195%
105	1.2195%
106	1.2195%
107	1.2195%
108	1.2195%
109	1.2195%
110	1.2195%
127	1.2195%
128	1.2195%
129	1.2195%
130	1.2195%
131	1.2195%
132	1.2195%
133	1.2195%
134	1.2195%
135	1.2195%
136	1.2195%

Pursuant to Section 2.1 of the Declaration and Master Deed of Stone Creek Village Condominium Property Regime, the above allocations are subject to recalculation upon the

creation of any additional Units, the reallocation of the boundaries of any Units, the conversion of Units into Common Elements or the conversion of Common Elements to Units.



MISC 2009038271



APR 21 2009 15:13 P 14

MISC 113.50 DJ-37088
 DJ-37089
 BNP _____ G/D _____ COMP _____
 DEL _____ STCH _____ FY _____

Received - DIANE L. BATTIATO
 Register of Deeds, Douglas County, NE
 4/21/2009 15:13:45.69



2009038271

**EIGHTH AMENDMENT TO
 DECLARATION AND MASTER DEED
 OF STONE CREEK VILLAGE
 CONDOMINIUM PROPERTY REGIME**

This Eighth Amendment to Declaration and Master Deed of Stone Creek Village Condominium Property Regime (this "Amendment") is made this 20 day of April, 2009, by Triton Homes, L.C., an Iowa limited liability company, doing business in Nebraska as Triton Homes, LLC, hereinafter referred to as the "Declarant".

PRELIMINARY STATEMENT

WHEREAS, Declaration is named as the declarant under the Declaration and Master Deed of Stone Creek Village Condominium Property Regime, dated the June 7, 2006 and filed with the Register of Deeds of Douglas County, Nebraska on June 8, 2006, instrument number 2006064045 as amended (the "Declaration");

WHEREAS, the Declarant, pursuant to Section 2.1 of the Declaration is granted the right and power to add additional units to the Stone Creek Village Condominium Property Regime (the "Condominium");

WHEREAS, the Declaration governs the ownership and use of all real property subject to the Declaration, as legally described on Exhibit "A", attached hereto and incorporated herein by reference; and

WHEREAS, the Declarant wished to amend the Declaration as set forth in this Amendment.

NOW, THEREFORE, pursuant to the authority to amend the Declaration set forth in Article XV of the Declaration, Declarant hereby makes the following amendments to the Declaration:

1. **Subdivision of Phase 15.** The Declaration allows for real estate to be subjected to the Declaration in phases. Such phases are identified within the Declaration pictorially by the attached entitled "PROPOSED CONDOMINIUM PHASING PARCELS", "STONE CREEK VILLAGE PHASING LEGAL DESCRIPTIONS" (the "Phasing Exhibits"). For the purpose of adding the whole of Phase 15a, the Phasing Exhibits are hereby deleted in their entirety and

replaced with the "Amended Phasing Attachments" attached hereto and incorporated by reference herein.

2. **Addition of Phases 15a and 16.** Phases 15a and 16 are hereby added and subjected to the Declaration. The whole of Phase 15a, and the Units contained therein, and Phase 16 are, by this Amendment, authorized for creation and addition to the Declaration, and the Owners of the Units in such phases are hereby granted rights as Unit Owners of the Condominium and members of the Village at Falcon Ridge Condominium Association, a Nebraska not-for-profit corporation.

3. **Amendment of Exhibit "C".** To reflect the addition of Units to the Declaration and Condominium, Exhibit "C" of the Declaration is hereby deleted in its entirety and replaced with the "Amended Exhibit "C" attached hereto and incorporated by reference herein.

Except as expressly amended herein, the terms and conditions of the Declaration shall continue in full force and effect.

Dated this 20 day of April, 2009.

DECLARANT:

TRITON HOMES, L.C., an Iowa limited liability company, doing business in Nebraska as TRITON HOMES, LLC

Chad Schwarting; Director

STATE OF NEBRASKA)
) ss.
COUNTY OF DOUGLAS)

The foregoing instrument was acknowledge before me this 20 day of April, 2009 by Chad Schwarting, on behalf of the company, Triton Homes, L.C., an Iowa limited liability company, doing business in Nebraska as Triton Homes, LLC director

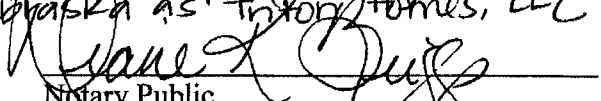
Notary Public

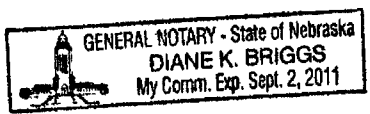

EXHIBIT "A"
Legal Description

05-37088

Lot 1, Stone Creek Village, a subdivision, as surveyed, platted and recorded in Douglas County, Nebraska;

AMENDED PHASING ATTACHMENTS

PROPOSED CONDOMINIUM PHASING PARCELS

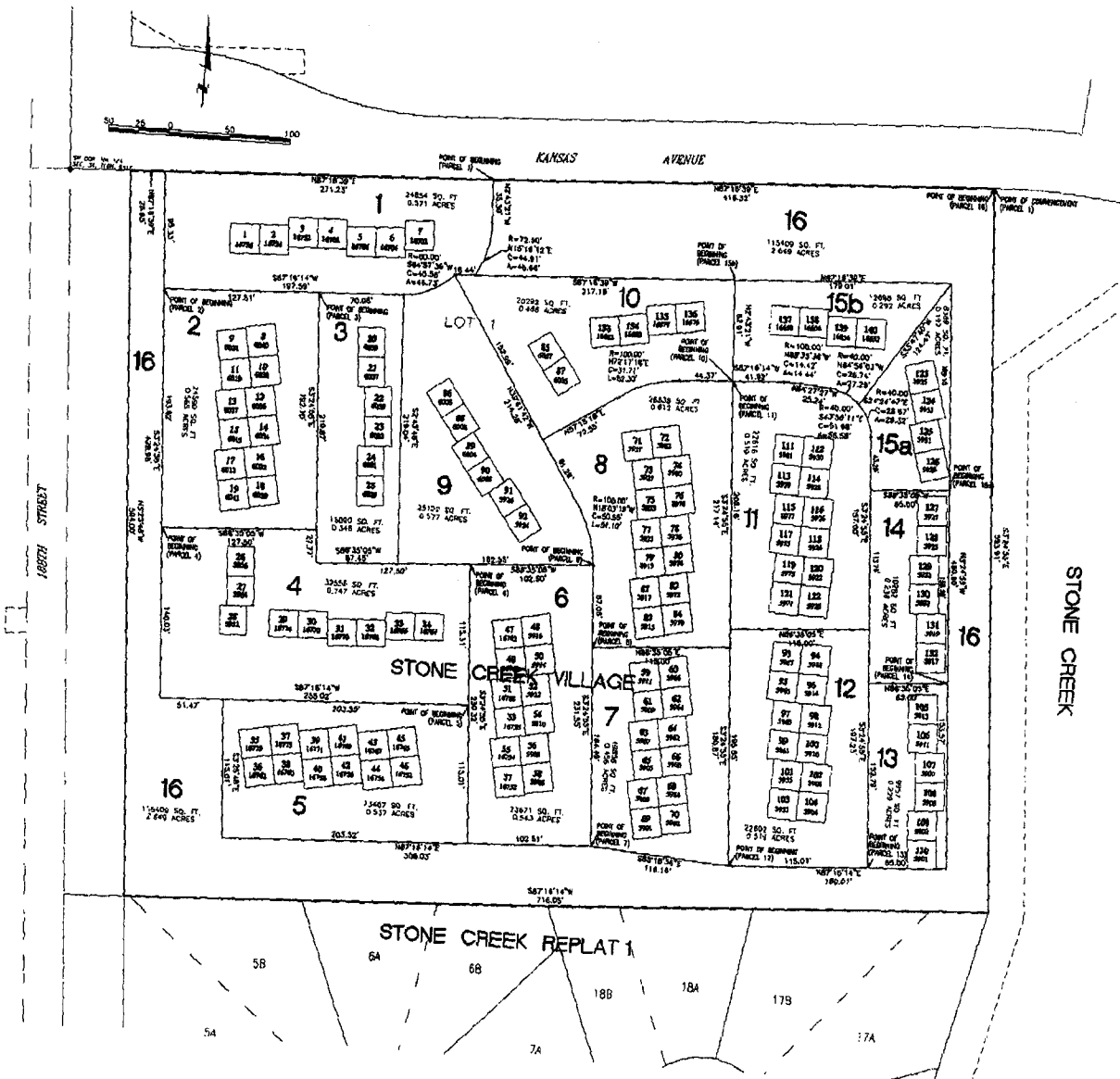

CONDOMINIUM PHASING PARCELS

PARCEL 1 LEGAL DESCRIPTION

That part of Lot 1, STONE CREEK VILLAGE, a subdivision, as surveyed, platted and recorded in Douglas County, Nebraska, described as follows:

Commencing at the northeast corner of said Lot 1;
 Thence South 87°16'39" West (bearings referenced to the Final Plat of STONE CREEK VILLAGE) for 416.32 feet along the north line of said Lot 1 to the TRUE POINT OF BEGINNING;
 Thence South 02°43'21" East for 35.30 feet;
 Thence along a curve to the right (having a radius of 72.50 feet and a long chord bearing South 15°19'12" West for 44.91 feet) for an arc length of 45.66 feet;
 Thence South 87°16'39" West for 16.44 feet;
 Thence along a curve to the right (having a radius of 60.00 feet and a long chord bearing South 64°57'36" West for 45.56 feet) for an arc length of 46.73 feet;
 Thence South 87°16'14" West for 197.59 feet;
 Thence North 03°24'55" West for 95.33 feet to the north line of said Lot 1;
 Thence North 87°16'39" East for 271.23 feet to the Point of Beginning.

The total area of parcel 1 is 24,848.40 sq. ft. or 0.57 acre, more or less.

PARCEL 2 LEGAL DESCRIPTION

That part of Lot 1, STONE CREEK VILLAGE, a subdivision, as surveyed, platted and recorded in Douglas County, Nebraska, described as follows:

Beginning at the southwest corner of the above described Parcel 1;
 Thence North 87°16'14" East (bearings referenced to the Final Plat of STONE CREEK VILLAGE) for 127.51 feet along the south line of said Parcel 1;
 Thence South 03°24'55" East for 192.10 feet;
 Thence South 86°35'05" West for 127.50 feet to the extended west line of said Parcel 1;
 Thence North 03°24'55" West for 193.62 feet to the Point of Beginning.

The total area of parcel 2 is 24,589.79 sq. ft. or 0.56 acre, more or less.

PARCEL 3 LEGAL DESCRIPTION

That part of Lot 1, STONE CREEK VILLAGE, a subdivision, as surveyed, platted and recorded in Douglas County, Nebraska, described as follows:

Beginning at the northeast corner of the above described Parcel 2;
 Thence North 87°16'14" East (bearings referenced to the Final Plat of STONE CREEK VILLAGE) for 70.08 feet along the south line of the above described Parcel 1;
 Thence South 02°43'46" East for 219.04 feet;
 Thence South 86°35'05" West for 67.45 feet to the extended east line of said Parcel 2;
 Thence North 03°24'55" West for 219.87 feet to the Point of Beginning.

The total area of parcel 3 is 15,135.34 sq. ft. or 0.35 acre, more or less.

PARCEL 4 LEGAL DESCRIPTION

That part of Lot 1, STONE CREEK VILLAGE, a subdivision, as surveyed, platted and recorded in Douglas County, Nebraska, described as follows:

Beginning at the southwest corner of the above described Parcel 2;

Thence North 86°35'05" East (bearings referenced to the Final Plat of STONE CREEK VILLAGE) for 127.50 feet to the southeast corner of said Parcel 2 and the west line the above describe Parcel 3;

Thence South 03°24'55" East for 27.77 feet along said west line to the southwest corner of said Parcel 3;

Thence North 86°35'05" East for 127.50 feet along the south line of said Parcel 3 extended east;

Thence South 03°24'55" East for 115.31 feet;

Thence South 87°16'14" West for 255.02 feet to the extended west line of said Parcel 2;

Thence North 03°24'55" West for 140.03 feet to the Point of Beginning.

The total area of parcel 4 is 32,555.60 sq. ft. or 0.75 acre, more or less.

PARCEL 5 LEGAL DESCRIPTION

That part of Lot 1, STONE CREEK VILLAGE, a subdivision, as surveyed, platted and recorded in Douglas County, Nebraska, described as follows:

Beginning at the southeast corner of the above described Parcel 4;

Thence South 03°24'55" East (bearings referenced to the Final Plat of STONE CREEK VILLAGE) for 115.01 feet along the extended east line of said Parcel 4;

Thence South 87°16'14" West for 203.52 feet;

Thence North 03°25'48" West for 115.01 feet to the south line of said Parcel 4;

Thence North 87°16'14" East for 203.55 feet to the Point of Beginning.

The total area of parcel 5 is 23,406.62 sq. ft. or 0.54 acre, more or less.

PARCEL 6 LEGAL DESCRIPTION

That part of Lot 1, STONE CREEK VILLAGE, a subdivision, as surveyed, platted and recorded in Douglas County, Nebraska, described as follows:

Beginning at the northeast corner of the above described Parcel 4;

Thence North 86°35'05" East (bearings referenced to the Final Plat of STONE CREEK VILLAGE) for 102.50 feet along the extended north line of said Parcel 4;

Thence South 03°24'55" East for 231.55 feet to the extended south line of the above described Parcel 5;

Thence South 87°16'44" West for 102.51 feet to the southeast corner of said Parcel 5;

Thence North 03°24'55" West for 230.32 feet along the east line of said Parcels 4 and 5 to the Point of Beginning.

The total area of parcel 6 is 23,628.62 sq. ft. or 0.54 acre, more or less.

7

PARCEL 7 LEGAL DESCRIPTION

That part of Lot 1, STONE CREEK VILLAGE, a subdivision, as surveyed, platted and recorded in Douglas County, Nebraska, described as follows:

Beginning at the southeast corner of the above described Parcel 6;

Thence North 03°24'55" West (bearings referenced to the Final Plat of STONE CREEK VILLAGE) for 164.49 feet along the east line of said Parcel 6;

Thence North 86°35'05" East for 115.00 feet;

Thence South 03°24'55" East for 180.87 feet;

Thence North 85°18'36" West for 116.16 feet to the Point of Beginning.

The total area of parcel 7 is 19,858.07 sq. ft. or 0.46 acre, more or less.

PARCEL 8 LEGAL DESCRIPTION

That part of Lot 1, STONE CREEK VILLAGE, a subdivision, as surveyed, platted and recorded in Douglas County, Nebraska, described as follows:

Beginning at the northwest corner of the above described Parcel 7;

Thence North 03°24'55" West (bearings referenced to the Final Plat of STONE CREEK VILLAGE) for 67.06 feet along the east line of the above described Parcel 6 to the northeast corner thereof;

Thence along a curve to the left (having a radius of 100.00 feet and a long chord bearing North 18°03'19" West for 50.55 feet) for an arc length of 51.10 feet;

Thence North 32°41'42" West for 61.29 feet;

Thence North 57°18'18" East for 72.55 feet;

Thence along a curve to the right (having a radius of 100.00 feet and a long chord bearing North 72°17'16" East for 51.71 feet) for an arc length of 52.30 feet;

Thence North 87°16'14" East for 44.37 feet to the extended east line of said Parcel 7;

Thence South 03°24'55" East for 217.14 feet to the northeast corner said Parcel 7;

Thence South 86°35'05" West for 115.00 feet to the Point of Beginning.

The total area of parcel 8 is 26,641.65 sq. ft. or 0.61 acre, more or less.

PARCEL 9 LEGAL DESCRIPTION

That part of Lot 1, STONE CREEK VILLAGE, a subdivision, as surveyed, platted and recorded in Douglas County, Nebraska, described as follows:

Beginning at the northeast corner of the above described Parcel 6;

Thence South 86°35'05" West (bearings referenced to the Final Plat of STONE CREEK VILLAGE) for 162.55 feet along the north line of the above described Parcels 4 and 6 to the southeast corner of the above described Parcel 3;

Thence North 02°43'46" West for 219.04 feet to the northeast corner of said Parcel 3;

Thence along a curve to the left (having a radius of 60.00 feet and a long chord bearing North 64°57'36" East for 45.56 feet) for an arc length of 46.73 feet along the south line of the above described Parcel 1;

Thence South 32°41'42" East for 214.28 feet along the extended west line of the above

described Parcel 8;

Thence along a curve to the right (having a radius of 100.00 feet and a long chord bearing South 18°03'19" East for 50.55 feet) for an arc length of 51.10 feet along said west line to the Point of Beginning.

The total area of parcel 9 is 25,079.59 sq. ft. or 0.58 acre, more or less.

PARCEL 10 LEGAL DESCRIPTION

That part of Lot 1, STONE CREEK VILLAGE, a subdivision, as surveyed, platted and recorded in Douglas County, Nebraska, described as follows:

Beginning at the northeast corner of the above described Parcel 8;

Thence South 87°16'14" West (bearings referenced to the Final Plat of STONE CREEK VILLAGE) for 44.37 feet along the north line of the above described Parcel 8;

Thence along a curve to the left (having a radius of 100.00 feet and a long chord bearing South 72°17'16" West for 51.71 feet) for an arc length of 52.30 feet along said north line;

Thence South 57°18'18" West for 72.55 feet along said north line to the east line of the above described Parcel 9;

Thence North 32°41'42" West for 152.99 feet along said east line to the south line of above described Parcel 1;

Thence North 87°16'39" East for 233.89 feet along the extended south line of said Parcel 1;

Thence South 02°43'21" East for 82.91 feet to the Point of Beginning.

The total area of parcel 10 is 20,245.72 sq. ft. or 0.46 acre, more or less.

PARCEL 11 LEGAL DESCRIPTION

That part of Lot 1, STONE CREEK VILLAGE, a subdivision, as surveyed, platted and recorded in Douglas County, Nebraska, described as follows:

Beginning at the northeast corner of the above described Parcel 8;

Thence North 87°16'14" East (bearings referenced to the Final Plat of STONE CREEK VILLAGE) for 41.92 feet along the extended north line of said Parcel 8;

Thence along a curve to the right (having a radius of 100.00 feet and a long chord bearing South 88°35'36" East for 14.42 feet) for an arc length of 14.44 feet;

Thence South 84°27'27" East for 25.24 feet;

Thence along a curve to the right (having a radius of 40.00 feet and a long chord bearing South 43°56'11" East for 51.98 feet) for an arc length of 56.58 feet;

Thence South 03°24'55" East for 157.00 feet

Thence South 86°35'05" West for 115.00 feet to the east line of the above described Parcel 8;

Thence North 03°24'55" West for 202.16 feet to the Point of Beginning.

The total area of parcel 11 is 22,499.89 sq. ft. or 0.52 acre, more or less.

PARCEL 12 LEGAL DESCRIPTION

That part of Lot 1, STONE CREEK VILLAGE, a subdivision, as surveyed, platted and recorded in Douglas County, Nebraska, described as follows:

Beginning at the southeast corner of the above described Parcel 7;

Thence North 03°24'55" West (bearings referenced to the Final Plat of STONE CREEK VILLAGE) for 195.85 feet along the east line of the above described Parcels 7 and 8 to the southwest corner of above describe Parcel 11;

Thence North 86°35'05" East for 115.00 feet to the southeast corner of said Parcel 11;

Thence South 03°24'55" East for 197.23 feet;

Thence South 87°16'14" West for 115.01 feet to the Point of Beginning.

The total area of parcel 12 is 22,472.19 sq. ft. or 0.52 acre, more or less.

PARCEL 13 LEGAL DESCRIPTION

That part of Lot 1, STONE CREEK VILLAGE, a subdivision, as surveyed, platted and recorded in Douglas County, Nebraska, described as follows:

Beginning at the southeast corner of the above described Parcel 12;

Thence North 03°24'55" West (bearings referenced to the Final Plat of STONE CREEK VILLAGE) for 152.79 feet along the east line of said Parcel 12;

Thence North 86°35'05" East for 65.00 feet;

Thence South 03°24'55" East for 153.57 feet to the extended south line of said Parcel 12;

Thence South 87°16'14" West for 65.00 feet to the Point of Beginning.

The total area of parcel 13 is 9,956.71 sq. ft. or 0.23 acre, more or less.

PARCEL 14 LEGAL DESCRIPTION

That part of Lot 1, STONE CREEK VILLAGE, a subdivision, as surveyed, platted and recorded in Douglas County, Nebraska, described as follows:

Beginning at the northeast corner of the above described Parcel 13;

Thence South 86°35'05" West (bearings referenced to the Final Plat of STONE CREEK VILLAGE) for 65.00 feet to the northwest corner of said Parcel 13 and the east line of the above described Parcel 12;

Thence North 03°24'55" West for 113.74 feet along the east line of the above described Parcels 11 and 12;

Thence North 86°35'05" East for 65.00 feet to the extended east line of said Parcel 13;

Thence South 03°24'55" East for 158.18 feet to the Point of Beginning.

The total area of parcel 14 is 10,281.84 sq. ft. or 0.24 acre, more or less.

PARCEL 15a LEGAL DESCRIPTION

That part of Lot 1, STONE CREEK VILLAGE, a subdivision, as surveyed, platted and recorded in Douglas County, Nebraska, described as follows:

Beginning at the northeast corner of the above described Parcel 14;

Thence North 03°24'55" West (bearing to the Final Plat of STONE CREEK VILLAGE) for 169.15 feet along the extended east line of said Parcel 14;

Thence South 33°47'40" West for 124.47 feet to the east line of the above described Parcel 11;

Thence along a curve to the right (having a radius of 40.00 feet and a long chord bearing South 24°24'47" East for 28.67 feet) for an arc length of 29.32 feet along said east line;

Thence South 03°24'55" East for 43.26 feet along said east line to the northwest corner of said Parcel 14;

Thence North 86°35'05" East for 65.00 feet along the north line of said Parcel 14 to the Point of Beginning.

PARCEL 15b LEGAL DESCRIPTION

That part of Lot 1, STONE CREEK VILLAGE, a subdivision, as surveyed, platted and recorded in Douglas County, Nebraska, described as follows:

Beginning at the northeast corner of the above described Parcel 10;

Thence North 87°16'39" East (bearings referenced to the Final Plat of STONE CREEK VILLAGE) for 179.01 feet to the northern corner of said Parcel 15a;

Thence South 33°47'40" West for 124.47 feet to the northwest corner of said Parcel 15a and the north line of Parcel 11;

Thence along said north line of Parcel 11 for the following (4) courses;

(1) Thence along a curve to the left (having a radius of 40.00 feet and a long chord bearing North 64°56'03" West for 26.74 feet) for an arc length of 27.26 feet;

(2) Thence North 84°27'27" West for 25.24 feet;

(3) Thence along a curve to the left (having a radius of 100.00 feet and a long chord bearing North 88°35'36" West for 14.42 feet) for an arc length of 14.44 feet;

(4) Thence South 87°16'14" West for 41.92 feet to the corner common to said Parcels B, 10, 11;

Thence North 02°43'21" West for 82.91 feet along the east line of said Parcel 10 to Point of Beginning.

PARCEL 16 LEGAL DESCRIPTION

That part of Lot 1, STONE CREEK VILLAGE, a subdivision, as surveyed, platted and recorded in Douglas County, Nebraska, described as follows:

Beginning at the northeast corner of the said Lot 1;

Thence South 03°24'55" East (bearings referenced to the Final Plat of STONE CREEK VILLAGE) for 593.91 feet to the southeast corner of said Lot 1;

Thence South 87°16'14" West for 716.05 feet to the southwest corner of said Lot 1;

Thence North 03°25'48" West for 594.00 feet to the northwest corner of said Lot 1;

Thence North $87^{\circ}16'39''$ East for 28.65 feet along the north line of said Lot 1 to the northwest corner of the above described Parcel 1;

Thence South $03^{\circ}24'55''$ East for 428.98 feet along the west line of the above described Parcels 1, 2 and 4 to the southwest corner of said Parcel 4;

Thence North $87^{\circ}16'14''$ East for 51.47 feet along the south line of said Parcel 4 to the northwest corner of the above described Parcel 5;

Thence South $03^{\circ}25'48''$ East for 115.01 feet to the southwest corner of said Parcel 5;

Thence North $87^{\circ}16'14''$ East for 306.03 feet along the south line of the above described Parcels 5 and 6 to the southeast corner of said Parcel 6;

Thence South $85^{\circ}18'36''$ East for 116.16 feet to the southwest corner of the above described Parcel 12;

Thence North $87^{\circ}16'14''$ East for 180.01 feet along the south line of the above described Parcels 12 and 13 to the southeast corner of said Parcel 13;

Thence North $03^{\circ}24'55''$ West for 480.90 feet along the east line of the above described Parcels 13, 14 and 15 to the northeast corner of said Parcel 15;

Thence South $87^{\circ}16'39''$ West for 396.17 feet along the north line of the above described Parcels 9, 10 and 15 to the east line of said Parcel 1;

Thence along a curve to the left (having a radius of 72.50 feet and a long chord bearing North $15^{\circ}19'12''$ East for 44.91 feet) for an arc length of 45.66 feet along said east line;

Thence North $02^{\circ}43'21''$ West for 35.30 feet along said east line to the north line of said Lot 1;

Thence North $87^{\circ}16'14''$ East for 416.32 feet to the Point of Beginning.

The total area of parcel 16 is 102,641.60 sq. ft. or 2.36 acres, more or less.

**EXHIBIT C
ALLOCATIONS**

Unit Number	Percentage
1	1.1628%
2	1.1628%
3	1.1628%
4	1.1628%
5	1.1628%
6	1.1628%
7	1.1628%
8	1.1628%
9	1.1628%
10	1.1628%
11	1.1628%
12	1.1628%
13	1.1628%
14	1.1628%
15	1.1628%
16	1.1628%
17	1.1628%
18	1.1628%
19	1.1628%
20	1.1628%
21	1.1628%
22	1.1628%
23	1.1628%
24	1.1628%
25	1.1628%
26	1.1628%
27	1.1628%
28	1.1628%
29	1.1628%
30	1.1628%
31	1.1628%
32	1.1628%
33	1.1628%
34	1.1628%
35	1.1628%
36	1.1628%
37	1.1628%
38	1.1628%
39	1.1628%

40	1.1628%
41	1.1628%
42	1.1628%
43	1.1628%
44	1.1628%
45	1.1628%
46	1.1628%
47	1.1628%
48	1.1628%
49	1.1628%
50	1.1628%
51	1.1628%
52	1.1628%
53	1.1628%
54	1.1628%
55	1.1628%
56	1.1628%
57	1.1628%
58	1.1628%
85	1.1628%
86	1.1628%
87	1.1628%
88	1.1628%
89	1.1628%
90	1.1628%
91	1.1628%
92	1.1628%
105	1.1628%
106	1.1628%
107	1.1628%
108	1.1628%
109	1.1628%
110	1.1628%
123	1.1628%
124	1.1628%
125	1.1628%
126	1.1628%
127	1.1628%
128	1.1628%
129	1.1628%
130	1.1628%
131	1.1628%
132	1.1628%
133	1.1628%
134	1.1628%

135	1.1628%
136	1.1628%

Pursuant to Section 2.1 of the Declaration and Master Deed of Stone Creek Village Condominium Property Regime, the above allocations are subject to recalculation upon the creation of any additional Units, the reallocation of the boundaries of any Units, the conversion of Units into Common Elements or the conversion of Common Elements to Units.



MISC 2009119400



NOV 05 2009 14:55 P 7

7/14/11 MISC 03-37088
 FEE 10550 FB 03-37089
 BKP _____ C/O _____ COMP CC
 DEL _____ SCAN _____ FV SB

Received - DIANE L. BATTIATO
 Register of Deeds, Douglas County, NE
 11/5/2009 14:55:06.37



2009119400

**NINTH AMENDMENT TO
 DECLARATION AND MASTER DEED
 OF STONE CREEK VILLAGE
 CONDOMINIUM PROPERTY REGIME**

This Ninth Amendment to Declaration and Master Deed of Stone Creek Village Condominium Property Regime (this "Amendment") is made this 5th day of November, 2009, by Triton Homes, L.C., an Iowa limited liability company, doing business in Nebraska as Triton Homes, LLC, hereinafter referred to as the "Declarant".

PRELIMINARY STATEMENT

WHEREAS, Declarant is named as the declarant under the Declaration and Master Deed of Stone Creek Village Condominium Property Regime, dated the June 7, 2006 and filed with the Register of Deeds of Douglas County, Nebraska on June 8, 2006, instrument number 2006064045 as amended (the "Declaration");

WHEREAS, the Declarant, pursuant to Section 2.1 of the Declaration is granted the right and power to add additional units to the Stone Creek Village Condominium Property Regime (the "Condominium");

WHEREAS, the Declaration governs the ownership and use of all real property subject to the Declaration, as legally described on Exhibit "A", attached hereto and incorporated herein by reference; and

WHEREAS, the Declarant wished to amend the Declaration as set forth in this Amendment.

NOW, THEREFORE, pursuant to the authority to amend the Declaration set forth in Article XV of the Declaration, Declarant hereby makes the following amendments to the Declaration:

Return to:
 Mark J. LaPuzza
 Pansing Hogan Ernst & Bachman, LLP
 10250 Regency Circle, Suite 300
 Omaha, Nebraska 68114

1. **Addition of Phases 7, 8, 11, 12 and 15b.** Phases 7, 8, 11, 12 and 15b are hereby added and subjected to the Declaration. The whole of Phases 7, 8, 11, 12 and 15b, and the Units contained therein, by this Amendment, authorized for creation and addition to the Declaration, and the Owners of the Units in such phases are hereby granted rights as Unit Owners of the Condominium and members of the Stone Creek Village Condominium Association, a Nebraska not-for-profit corporation.

3. **Amendment of Exhibit "C".** To reflect the addition of Units to the Declaration and Condominium, Exhibit "C" of the Declaration is hereby deleted in its entirety and replaced with the "Amended Exhibit "C" attached hereto and incorporated by reference herein.

Except as expressly amended herein, the terms and conditions of the Declaration shall continue in full force and effect.

Dated this 5th day of November, 2009.

DECLARANT:

TRITON HOMES, L.C., an Iowa limited liability company, doing business in Nebraska as TRITON HOMES, LLC

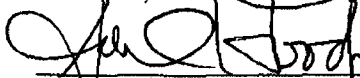

Joel Goodman, Director *AK/SK*

STATE OF NEBRASKA)
) ss.
COUNTY OF DOUGLAS)

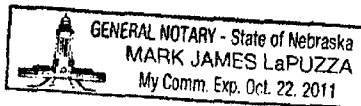

The foregoing instrument was acknowledge before me this 5th day of ~~October~~ ^{Nov.}, 2009 by Joel Goodman on behalf of the company.

Director AK/SK



Notary Public

EXHIBIT "A"
Legal Description

Lot 1, Stone Creek Village, a subdivision, as surveyed, platted and recorded in Douglas County, Nebraska;

Also known as:

Units 1-140, inclusive, and all common elements of Stone Creek Village Condominium Property Regime, as created by the Declaration and Master Deed Stone Creek Village Condominium Property Regime, recorded in the office of the Douglas County Register of Deeds on June 8, 2006 at Instrument Number 2006064045, as amended.

**EXHIBIT C
ALLOCATIONS**

Unit Number	Percentage
1	0.7142%
2	0.7142%
3	0.7142%
4	0.7142%
5	0.7142%
6	0.7142%
7	0.7142%
8	0.7142%
9	0.7142%
10	0.7142%
11	0.7142%
12	0.7142%
13	0.7142%
14	0.7142%
15	0.7142%
16	0.7142%
17	0.7142%
18	0.7142%
19	0.7142%
20	0.7142%
21	0.7142%
22	0.7142%
23	0.7142%
24	0.7142%
25	0.7142%
26	0.7142%
27	0.7142%
28	0.7142%
29	0.7142%
30	0.7142%
31	0.7142%
32	0.7142%
33	0.7142%
34	0.7142%
35	0.7142%
36	0.7142%
37	0.7142%
38	0.7142%

39	0.7142%
40	0.7142%
41	0.7142%
42	0.7142%
43	0.7142%
44	0.7142%
45	0.7142%
46	0.7142%
47	0.7142%
48	0.7142%
49	0.7142%
50	0.7142%
51	0.7142%
52	0.7142%
53	0.7142%
54	0.7142%
55	0.7142%
56	0.7142%
57	0.7142%
58	0.7142%
59	0.7142%
60	0.7142%
61	0.7142%
62	0.7142%
63	0.7142%
64	0.7142%
65	0.7142%
66	0.7142%
67	0.7142%
68	0.7142%
69	0.7142%
70	0.7142%
71	0.7142%
72	0.7142%
73	0.7142%
74	0.7142%
75	0.7142%
76	0.7142%
77	0.7142%
78	0.7142%
79	0.7142%
80	0.7142%
81	0.7142%
82	0.7142%
83	0.7142%

84	0.7142%
85	0.7142%
86	0.7142%
87	0.7142%
88	0.7142%
89	0.7142%
90	0.7142%
91	0.7142%
92	0.7142%
93	0.7142%
94	0.7142%
95	0.7142%
96	0.7142%
97	0.7142%
98	0.7142%
99	0.7142%
100	0.7142%
101	0.7142%
102	0.7142%
103	0.7142%
104	0.7142%
105	0.7142%
106	0.7142%
107	0.7142%
108	0.7142%
109	0.7142%
110	0.7142%
111	0.7142%
112	0.7142%
113	0.7142%
114	0.7142%
115	0.7142%
115 116	0.7142%
117	0.7142%
118	0.7142%
119	0.7142%
120	0.7142%
121	0.7142%
122	0.7142%
123	0.7142%
124	0.7142%
125	0.7142%
126	0.7142%
127	0.7142%
128	0.7142%

OK

129	0.7142%
130	0.7142%
131	0.7142%
132	0.7142%
133	0.7142%
134	0.7142%
135	0.7142%
136	0.7142%
137	0.7142%
138	0.7142%
139	0.7142%
140	0.7142%

Pursuant to Section 2.1 of the Declaration and Master Deed of Stone Creek Village Condominium Property Regime, the above allocations are subject to recalculation upon the creation of any additional Units, the reallocation of the boundaries of any Units, the conversation of Units into Common Elements or the conversation of Common Elements to Units.